

ECO LUXON ZERON

LIGHTING

COLLECTION

PT CIPTA SINERGI ASIA

ECO LUXON ZERON

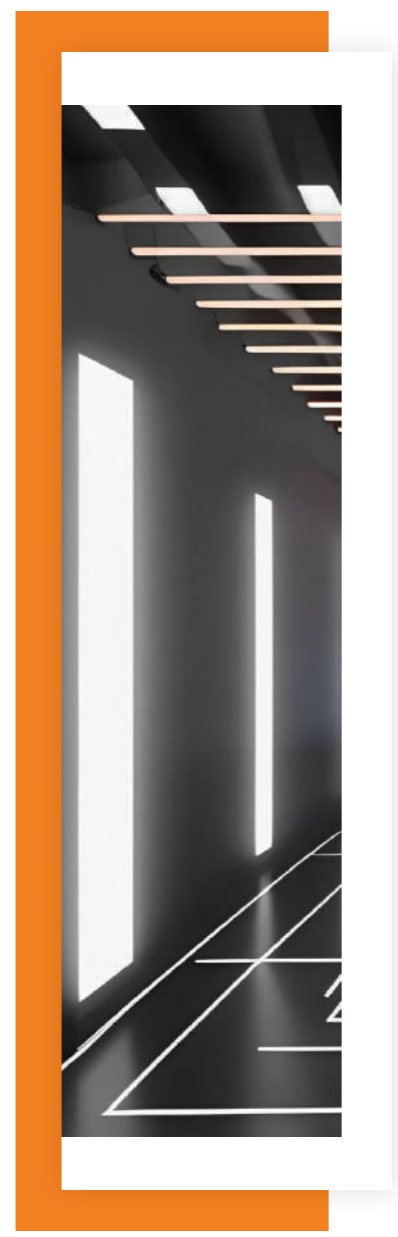

ECO LUXON ZERON

LIGHTING PRODUCT 2025

- Indoor Lighting •
- Outdoor Lighting •
- Explosion Proof •
- Inground Lighting •
- Underwater •
- Spot Light •
- Step Light •
- Wall Lamp •
- Garden Light •
- Accessories •

 **PT. Cipta Sinergi Asia**
Specialist LED

Head Office
Jl. H. Ten Raya No.45-65, RT.6/RW.1
Rawamangun, Kec. Pulo Gadung, Jakarta Timur
DKI Jakarta - Indonesia 13220
Tel +62 21 4786 4822

Indonesia Factory
Jl. Raya Gombang No 37 Blok Pelita
RT.12/RW. 03 Desa Gombang, Kec. Plumbon
Kab. Cirebon, Jawa Barat - Indonesia 45155
Tel +62 231 8821 214

China Factory
JOHO LIGHTING., LTD
3/F, 12th Building, Tangtou 3rd Industrial
Park, ShiYan BaoAn District, Shenzen, China
Tel +62 231 8821 214

KOMITMEN KAMI

Jujur
Menepati Janji
Melakukan yang terbaik

KAMI SELALU BEKERJA DENGAN SEPENUH HATI

Komitmen pada pelanggan adalah kunci sukses dibalik tumbuhnya PT Cipta Sinergi Asia sebagai perusahaan di bidang pencahayaan. Dalam memenuhi kepercayaan pelanggan, Kami akan memberikan yang terbaik dan terus melangkah ke depan.

FILOSOFI PERUSAHAAN

- Perusahaan yang memiliki profit tinggi
- Dengan fondasi yang kokoh, kami akan menjadi perusahaan yang maju
- Perusahaan yang memiliki kompetensi tinggi dalam bisnis
- Kami akan menjadi perusahaan yang kompetitif dengan memperkuat kemampuan kami melalui pengembangan teknologi profesional serta pengembangan produk berdasarkan talenta dan teknologi terbaik
- Perusahaan yang menciptakan nilai produk berharga dan secara proaktif menanggapi perusahaan pasar
- Melalui pengembangan dan penelitian yang berkelanjutan, kami akan meningkatkan nilai produk dan menjadi perusahaan di bidang pencahayaan yang terkemuka
- Perusahaan yang berorientasi ke depan serta menghargai nilai kehidupan
- Kami akan menjadi perusahaan yang menciptakan kehidupan nyaman dengan ide-ide dan pengembangan teknologi untuk kehidupan yang lebih baik dan ramah lingkungan

















HISTORI PERUSAHAAN

- 2012.01** Berdirinya PT Cipta Sinergi Asia.
- 2013.06** Mendapatkan sertifikasi registrasi dari PT Pertamina Retail untuk mensuplai lampu LED di banyak SPBU Pertamina di Seluruh Indonesia.
- 2014.07** Membuat merek sendiri yaitu LUXON, ZERON, dan ECOLUXON.
- 2015.01** Lampu LED merek LUXON, ZERON dan ECOLUXON sudah mulai dipasarkan.
- 2016.07** Menjadi Supplier lampu untuk Masjid Raya Baiturrahman, Aceh.
- 2018.02** Dimulainya pembangunan pabrik perakitan lampu LED PT Cipta Sinergi Asia di Cirebon, Jawa Barat.
- 2019.01** Diresmikannya Pabrik perakitan lampu LED PT Cipta Sinergi Asia di Cirebon, Jawa Barat, diikuti dengan terbitnya sertifikat Sistem Manajemen Mutu (ISO 9001) dan Sistem Manajemen Lingkungan (ISO 14001).
- 2019.06** PT Cipta Sinergi Asia bekerja sama dengan Sucofindo Laboratorium sebagai salah satu subcon uji luminer.
- 2019.08** Diterbitkannya sertifikat Standar Nasional Indonesia (SNI) oleh Sucofindo Laboratorium untuk produk ZERON dan ECOLUXON.
- 2019.09** Menjadi Supplier lampu LED PT Lotte Shopping Indonesia yang mensuplai lampu LED untuk Lotte Mart dan Lotte Grosir Seluruh Indonesia.
- 2020.04** Proses pembangunan produk Tingkat Komponen Dalam Negri (TKDN) yang ditargetkan sebesar 40%.
- 2021.05** Mendapatkan kontrak dengan Agung Podomoro Group untuk mensuplai Lampu LED di banyak gedung Apartemen dan Mall Agung Podomoro Group di seluruh Indonesia.
- 2021.07** Diterbitkannya sertifikat Sistem Manajemen Kesehatan dan Keselamatan Kerja (ISO 45001).
- 2022.05** Pengembangan produk Smart System PJU, yaitu sistem PJU yang dapat sepenuhnya memonitoring dan mengendalikan pemakaian daya secara real time.
- 2022.08** Produk ZERON dan ECOLUXON mulai masuk ke dalam E-Catalogue, dimulai dari tipe Street Light, Flood Light dan All In One solar Street Light.
- 2024.00** PT. Cipta Sinergi Asia kedatangan SMT Machine, Teknologi canggih yang membawa revolusi dalam kualitas dan efisiensi produksi.



CONTENT

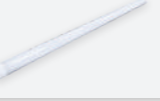

















INDOOR LIGHT

Page 1-7 TUBE LIGHT 	Page 8 TRIPROOF LIGHT 	Page 9-36 DOWNLIGHT LIGHT 	Page 37 TRACK LIGHT 	Page 38 MOISTURE PROOF LIGHT 
Page 39 AR111 LIGHT 	Page 40-41 MR16 LIGHT 	Page 42 BULB LIGHT 	Page 43 PAR30 LIGHT 	Page 44 STRIP LIGHT 
Page 45-46 FLAT LIGHT 	Page 47-48 LINE GRILL LIGHT 	Page 49 RACEWAY LIGHT 	Page 50 DUSTPROOF LIGHT 	Page 51-52 EMERGENCY LIGHT 

OUTDOOR LIGHT

Page 53-55 STREET LIGHT 	Page 56-57 ALL IN ONE SOLAR LIGHT 	Page 58-62 FLOOD LIGHT 	Page 63-65 HIGH BAY LIGHT 	Page 66 OBSTRUCTION LIGHT 
--	--	---	---	--

EXPLOSION PROOF

Page 67 OHBF8230-SS EXPLOSION PROOF 	Page 68 OHBF8230-BS EXPLOSION PROOF 	Page 69 OHBF8231 EXPLOSION PROOF 	Page 70 OHBF8236 EXPLOSION PROOF 	Page 71 OHBF8235 EXPLOSION PROOF 
Page 72 OHBF8260-SS EXPLOSION PROOF 	Page 73 OHBF8260-MS EXPLOSION PROOF 	Page 74 OHBF8260-BS EXPLOSION PROOF 	Page 75 OHBF8266-SS EXPLOSION PROOF 	Page 76 OHBF8266-BS EXPLOSION PROOF 
Page 77 OHBF8189 EXPLOSION PROOF 	Page 78 OHBF8269 EXPLOSION PROOF 	Page 79 OHBF8191 EXPLOSION PROOF 	Page 80 OHBF8190 EXPLOSION PROOF 	Page 81 OHBF51S/D EXPLOSION PROOF 
Page 82 OHBF8192 EXPLOSION PROOF 	Page 83 OHBF8192-600 EXPLOSION PROOF 	Page 84 OHBF8192-1200 EXPLOSION PROOF 		

INGROUND LIGHT

Page 85-86 ZERN-UGL-2,5W – ZERN-UGL-5,2W – ZERN-UGL-12W INGROUND LIGHT   	Page 86-87 ZERN-UGL-13,5W – ZERN-UGLS 5,2W – ZERN-UGLS-13,5W INGROUND LIGHT   	Page 88-90 ZERN-ASMG – ZERN-ALTD WALL WASHER    
---	--	---









UNDERWATER LIGHT

Page 91 ZERN-UWL-2,6W – ZERN-UWL-8,9W UNDERWATER LIGHT   	Page 92 ZERN-UWL-16,8W – ZERN-UWL-28,8W UNDERWATER LIGHT  	Page 93-94 ZERN-UWL-45,6W – ZERN-UWLH-15,5W – ZERN-UWLH-28,8W UNDERWATER LIGHT   	Page 93 ZERN-RC-SS160L UNDERWATER LIGHT  	Page 96-98 ZERN-SL150/SL180 – ZERN-FL170-32/FL192-50 – ZERN-RC-SS280L UNDERWATER LIGHT      
---	---	---	--	---

SPOT LIGHT

Page 99 ZERN-GSL-3W – ZERN-GSL-5W SPOT LIGHT  	Page 100 ZERN-GSL-6W/9W – ZERN-GSL-10W/12W SPOT LIGHT  	Page 101 ZERN-GSL-18W/27W – ZERN-GSL-36W SPOT LIGHT  	Page 102-103 ZERN-GSL-4W/8W – ZERN-GSL-18W/27W – ZERN-GSL-36W/48W SPOT LIGHT   
---	--	--	--

STEP LIGHT

Page 104-105 ZERN-SLS-3W – ZERN-SLS-3W – ZERN-SLR-3W – ZERN-SLR-5W STEP LIGHT    	Page 106-107 ZERN-RLR-3W – ZERN-SL-3W – ZERN-SL-5W – ZERN-SL-10W STEP LIGHT    
--	--

GARDEN LIGHT & ACCESSORIES

Page 108-120 GARDEN LIGHT  WALL LAMP  BOLLARD LIGHT 	Page 121-124 SMPS – DRIVER – EMERGENCY – HOUSING ACCESSORIES    
--	---

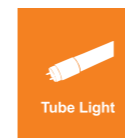

INDOOR LIGHTING



Tube Light Ecoluxon

ELX-T8



■ Specification

Daya (W)	Input Voltage	Frequency Amp	LED Efikasi	Total Lumen	CRI	Temperatur Warna	Proteksi	Berat	Material
9W	AC100-265V	50/60Hz	140Lm/W, 170Lm/W	1.260/1.530Lm	>80Ra	3000K/6000K	IP20	72.5gr	Nano PC Cover
18W	AC100-265V	50/60Hz	140Lm/W, 170Lm/W	2.520/3.060Lm	>80Ra	3000K/6000K	IP20	127gr	Nano PC Cover

Model : ELX-T8-600-9W



Dimension (mm)

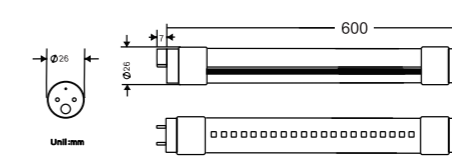

Light Distribution Curve

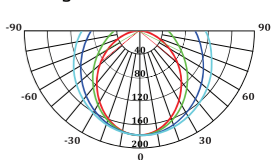

Model : ELX-T8-1200-18W



Dimension (mm)

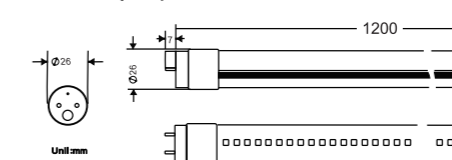

Light Distribution Curve

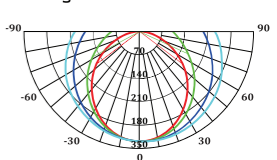

- * Easy maintenance
- Modular LED for easy replacement
- Opening and closing possible of LED module part and power supply part
- Customizable beam angle
- Temperature max 50°

ECO
LUXON
Tube Light Ecoluxon
ELX-T8-AL

140
lm/W



ZERON
NEW LIGHT NEW LIFE
Tube Light Zeron
ZERN-T8

170
lm/W



Specification

Daya (W)	Input Voltage	Frequency Amp	LED Efikasi	Total Lumen	CRI	Temperatur Warna	Proteksi	Berat	Material
9W	AC100-265V	50/60Hz	140Lm/W	1.260Lm	>80Ra	3000K/4000K/6000K	IP20	119.5gr	Aluminium + PC Cover
18W				2.520Lm				212.5gr	
25W				3.500Lm				218.5gr	

Specification

Daya (W)	Input Voltage	Frequency Amp	LED Efikasi	Total Lumen	CRI	Temperatur Warna	Proteksi	Berat	Material
5,2W	AC100-265V	50/60Hz	170Lm/W	884Lm	>80Ra	3000K/4000K/6000K	IP20	63.5gr	Nano PC Cover
10,5W	AC100-265V	50/60Hz	170Lm/W	1.785Lm	>80Ra	3000K/4000K/6000K	IP20	127gr	Nano PC Cover

Model : ELX-T8-600AL-9W



Dimension (mm)

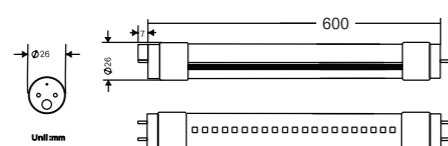

Light Distribution Curve

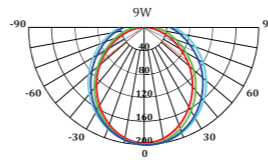

Model : ZERN-T8-600-5,2W



Dimension (mm)

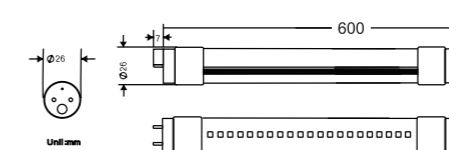

Light Distribution Curve

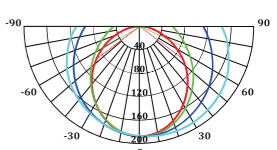

Model : ELX-T8-1200AL-18W



Dimension (mm)

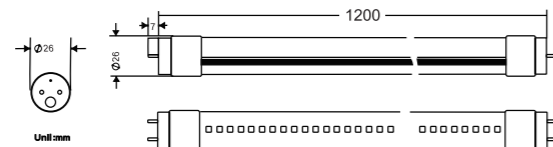

Light Distribution Curve

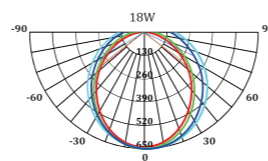

Model : ZERN-T8-1200-10,5W



Dimension (mm)

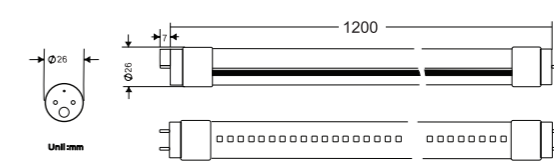

Light Distribution Curve

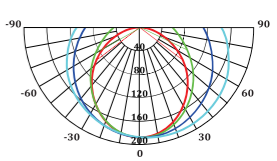

Model : ELX-T8-1200AL-25W



Dimension (mm)

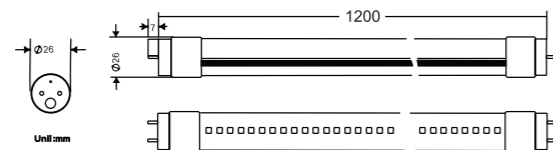

Light Distribution Curve

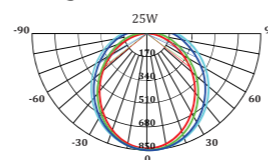

* Easy maintenance
- Modular LED for easy replacement
- Opening and closing possible of LED module part and power supply part
- Customizable beam angle
- Temperature max 50°

* Easy maintenance
- Modular LED for easy replacement
- Opening and closing possible of LED module part and power supply part
- Customizable beam angle
- Temperature max 50°

ECO
LUXON
Tube Light Ecoluxon
ELX-T8-SM

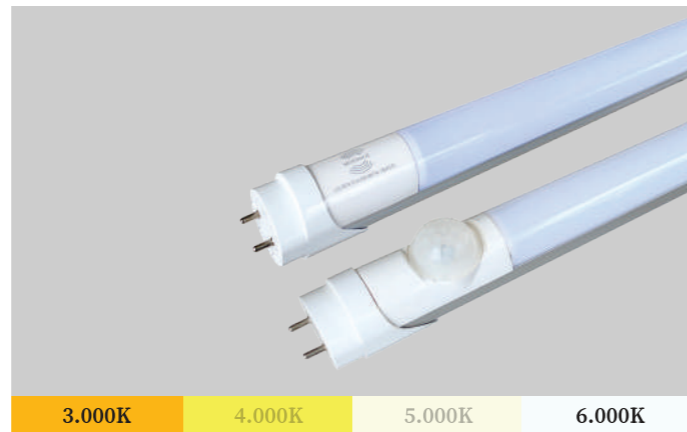

3.000K 4.000K 5.000K 6.000K

■ **Specification**

Daya (W)	Input Voltage	Frequency Amp	LED Efikasi	Total Lumen	CRI	Temperatur Warna	THD	Daya Standby	Berat	Material
9W	AC100-265V	50/60Hz	140Lm/W	1.260Lm	>80Ra	3000K/6000K	<20	123.5gr	123.5gr	PC Cover + Aluminium
18W	AC100-265V	50/60Hz	140Lm/W	2.520Lm	>80Ra	3000K/6000K	<20	226.5gr	226.5gr	PC Cover + Aluminium

Model : ELX-T8-600SM-9W



Dimension (mm)

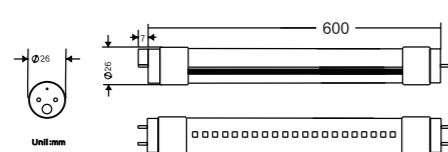

Light Distribution Curve

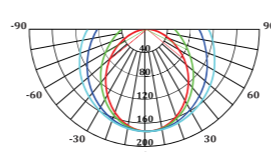

Model : ELX-T8-1200SM-18W



Dimension (mm)

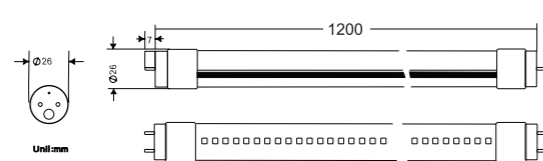

Light Distribution Curve

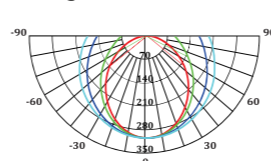

- * Easy maintenance
- Modular LED for easy replacement
- Opening and closing possible of LED module part and power supply part
- Customizable beam angle
- Temperature max 50°



ECO
LUXON
Tube Light Ecoluxon
EXL-T5300-ECOSM



3.000K 4.000K 5.000K 6.000K

■ **Specification**

Daya (W)	Input Voltage	Frequency Amp	LED Efikasi	Total Lumen	CRI	Temperatur Warna	Proteksi	Berat	Material
4W	AC100-265V	50/60Hz	110Lm/W	440Lm	>80Ra	3000K/6000K	IP20	42gr	Die Casting Aluminium
8W			880Lm	65gr					
12W			1.320Lm	96gr					
16W			1.760Lm	118gr					

Model : ELX-T5300-ECOSM-4W



Dimension (mm)



Light Distribution Curve

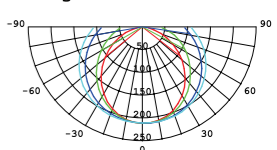

Model : ELX-T5600-ECOSM-8W



Dimension (mm)

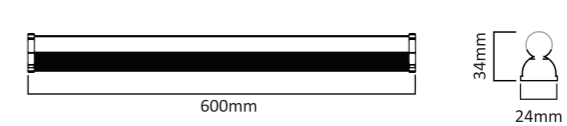

Light Distribution Curve

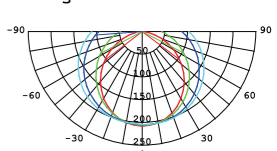

Model : ELX-T5900-ECOSM-12W



Dimension (mm)

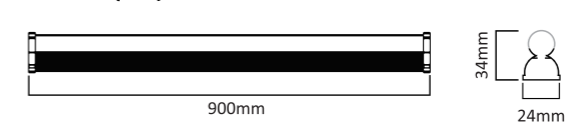

Light Distribution Curve

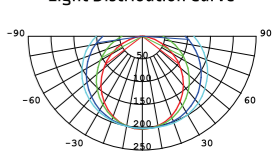

Model : ELX-T51200-ECOSM-16W



Dimension (mm)



Light Distribution Curve

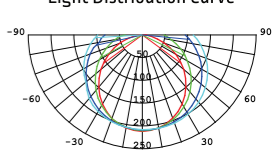

- * Easy maintenance
- Modular LED for easy replacement
- Opening and closing possible of LED module part and power supply part
- Customizable beam angle
- Temperature max 50°



ECO
LUXON
Integrated T8 Tubelight
ELX-IT8-1200AL

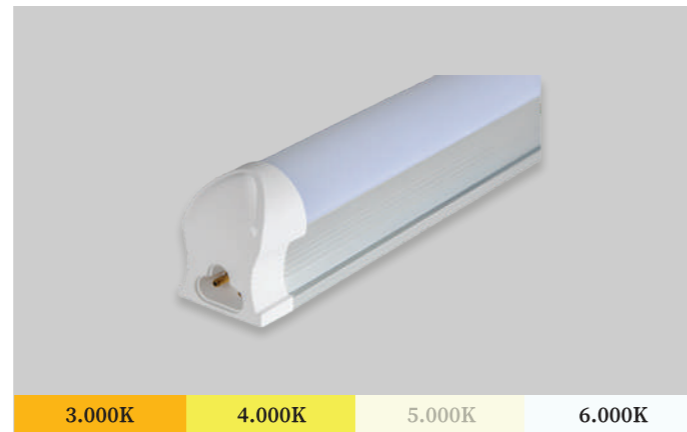

Specification

Daya (W)	Input Voltage	Frequency Amp	LED Efikasi	Total Lumen	CRI	Temperatur Warna	Proteksi	Material
18W 30W 50W	AC100-240V	50/60Hz	120Lm/W	2.160Lm 3.600Lm 6.000Lm	>80Ra	3000K/4000K/6000K	IP20	Aluminium + PC

Model : ELX-IT8-600AL-18W



Dimension (mm)

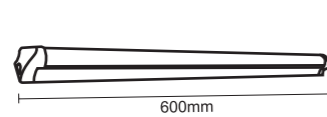

Light Distribution Curve

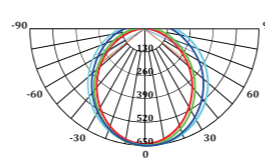

Model : ELX-IT8-1200AL-30W

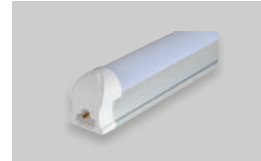

Dimension (mm)

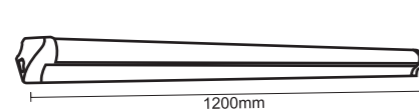

Light Distribution Curve

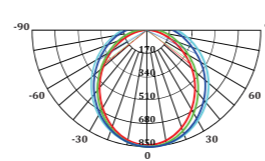

Model : ELX-IT8-1200AL-50W



Dimension (mm)

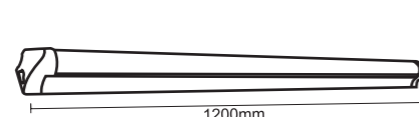

Light Distribution Curve

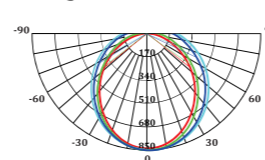

* Easy maintenance
- Modular LED for easy replacement
- Opening and closing possible of LED module part and power supply part
- Customizable beam angle
- Temperature max 50°



ECO
LUXON
Balk Tubelight
ELX-IT8-1200



Specification

Daya (W)	Input Voltage	Frequency Amp	LED Efikasi	Total Lumen	CRI	Temperatur Warna	Proteksi	Material
18W	AC100-240V	50/60Hz	170Lm/W	3.060Lm	>80Ra	3000K/6000K	IP20	Aluminium+PC

Model : ELX-IT8-1200-18W



Dimension (mm)

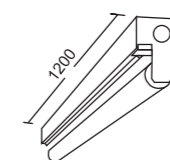

Light Distribution Curve

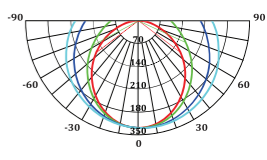

Application



* Easy maintenance
- Modular LED for easy replacement
- Opening and closing possible of LED module part and power supply part
- Customizable beam angle
- Temperature max 50°



ZERON
NEW LIGHT NEW LIFE

Triproof Light

ZERN-H03L

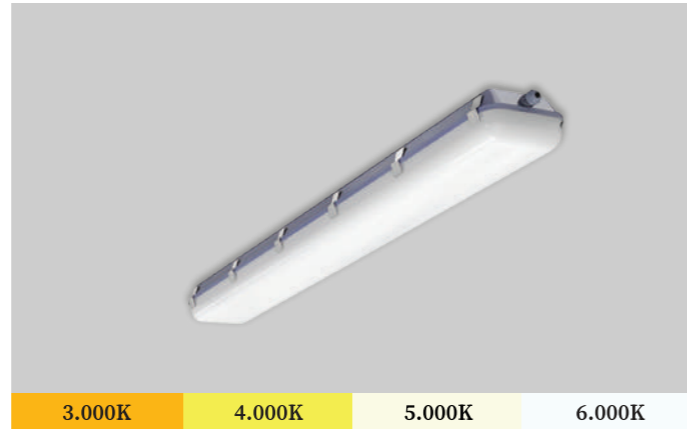

3.000K 4.000K 5.000K 6.000K

Specification

Daya (W)	Input Voltage	Frequency Amp	LED Efikasi	Total Lumen	CRI	Temperatur Warna	Proteksi	Material
20W	AC100-277V	50/60Hz	130Lm/W	2.600Lm	>80Ra	3000K/4000K/5000K/6000K	IP65	Die Casting Aluminium
50W				6.500Lm				
60W				7.800Lm				

Model : ZERN-H03L-20W



Dimension (mm)

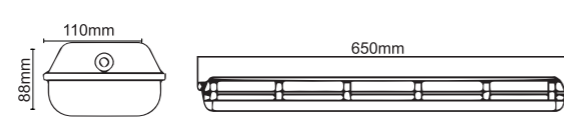

Model : ZERN-H03L-50W



Dimension (mm)

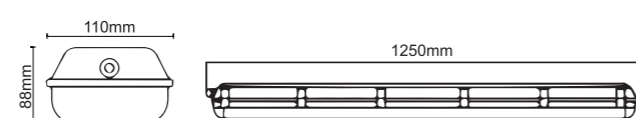

Model : ZERN-H03L-60W



Dimension (mm)

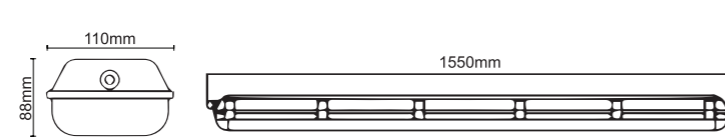

- * Easy maintenance
- Modular LED for easy replacement
- Opening and closing possible of LED module part and power supply part
- Customizable beam angle
- Temperature max 50°



ZERON
NEW LIGHT NEW LIFE

Downlight Zeron

ZERN-COBDH-ZRSM



3.000K 4.000K 5.000K 6.000K

Specification

Daya (W)	Input Voltage	Frequency Amp	LED Efikasi	Total Lumen	CRI	Temperatur Warna	Proteksi	Berat	Material
20W	AC175-265V	50/60Hz	90Lm/W	1.800Lm	>80Ra Optional {>90Ra, >95Ra}	3000K/4000K/6000K	IP20	476gr	Die Casting Aluminium
30W				2.700Lm				616gr	
40W				3.600Lm				939gr	

Model : ZERN-COBDH-ZRSM-20W



Dimension (mm)

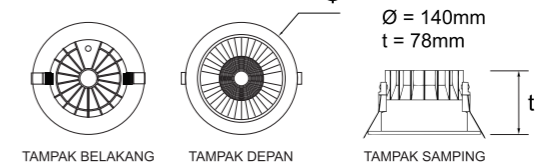

Light Distribution Curve

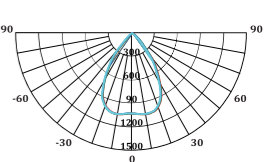

Model : ZERN-COBDH-ZRSM-30W



Dimension (mm)

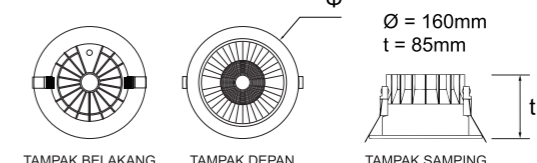

Light Distribution Curve

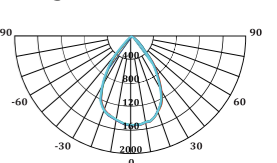

Model : ZERN-COBDH-ZRSM-40W



Dimension (mm)

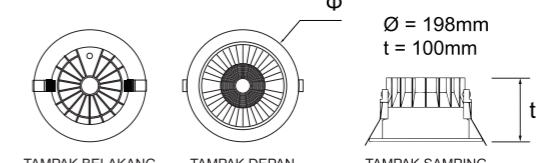

Light Distribution Curve

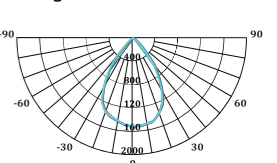

- * Easy maintenance
- Modular LED for easy replacement
- Opening and closing possible of LED module part and power supply part
- Customizable beam angle
- Temperature max 50°



ECO
LUXON
Downlight Ecoluxon
ELX-ECDL-COB

120
lm/W



ECO
LUXON
Downlight Ecoluxon
ELX-DL-SMD

110
lm/W



■ Specification

Daya (W)	Input Voltage	Frequency Amp	LED Efikasi	Total Lumen	CRI	Temperatur Warna	Proteksi	Beam Angle	Berat	Material
5W	AC85-265V	50/60Hz	120Lm/W	600Lm	>80Ra	3000K/4000K/6000K	IP20	30°	93gr	Die Casting Aluminium
8W				960Lm					130gr	
12W				1.440Lm					238gr	
15W				1.800Lm					413gr	

Specification

Daya (W)	Input Voltage	Frequency Amp	LED Efikasi	Total Lumen	CRI	Temperatur Warna	Proteksi	Berat	Material
6W	AC165-265V	50/60Hz	110Lm/W	660Lm	>80Ra	3000K/4000K/6000K	IP20	80gr	Die Casting Aluminium
9W				990Lm				110gr	
12W				1.320Lm				150gr	
18W				1.980Lm				210gr	

Model : ELX-ECDL-COB-5W



Dimension (mm)

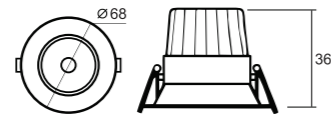

Light Distribution Curve

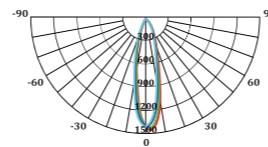

Model : ELX-DL-SMD-6W



Dimension (mm)

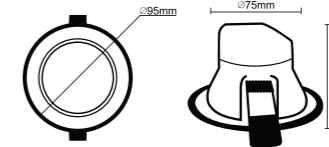

Light Distribution Curve

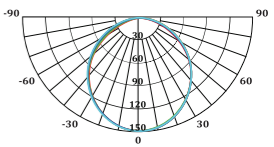

Model : ELX-ECDL-COB-8W



Dimension (mm)

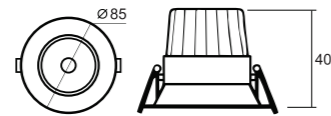

Light Distribution Curve

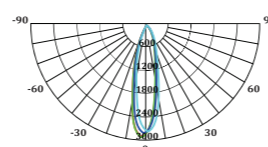

Model : ELX-DL-SMD-9W



Dimension (mm)

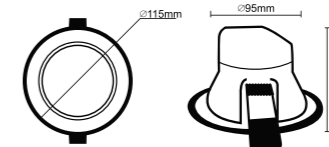

Light Distribution Curve

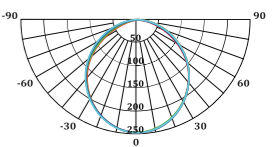

Model : ELX-ECDL-COB-12W



Dimension (mm)

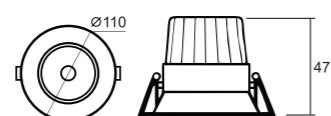

Light Distribution Curve

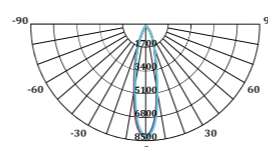

Model : ELX-DL-SMD-12W



Dimension (mm)

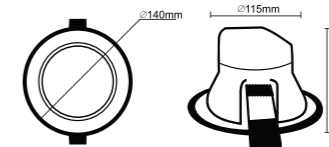

Light Distribution Curve

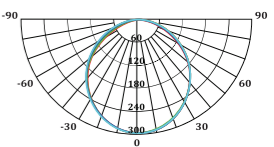

Model : ELX-ECDL-COB-15W



Dimension (mm)

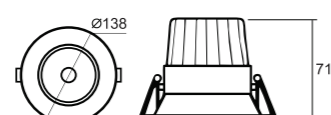

Light Distribution Curve

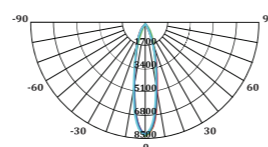

Model : ELX-DL-SMD-18W



Dimension (mm)

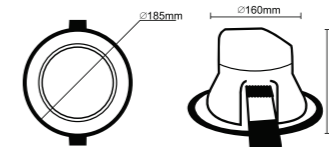

Light Distribution Curve

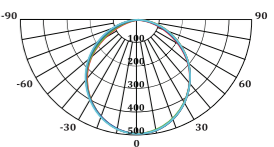

* Easy maintenance
- Modular LED for easy replacement
- Opening and closing possible of LED module part and power supply part
- Customizable beam angle
- Temperature max 50°

* Easy maintenance
- Modular LED for easy replacement
- Opening and closing possible of LED module part and power supply part
- Customizable beam angle
- Temperature max 50°

ECO
LUXON
Downlight Ecoluxon
ELX-SLDR



■ Specification

Daya (W)	Input Voltage	Frequency Amp	LED Efikasi	Total Lumen	CRI	Temperatur Warna	Proteksi	Berat	Material
6W	AC165-265V	50/60Hz	100Lm/W	600Lm	>80Ra	3000K/4000K/6000K	IP20	110gr	Die Casting Aluminium
9W				900Lm				150gr	
12W				1.200Lm				190gr	
18W				1.800Lm				270gr	
24W				2.400Lm				470gr	

Model : ELX-SLDR-6W



Dimension (mm)

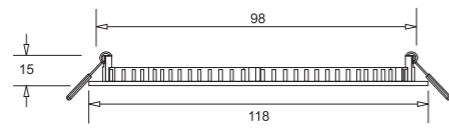

Light Distribution Curve

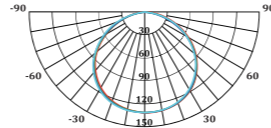

Model : ELX-SLDR-9W



Dimension (mm)

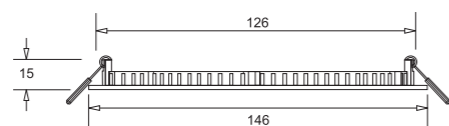

Light Distribution Curve

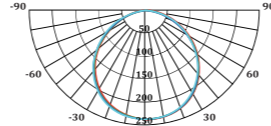

Model : ELX-SLDR-12W



Dimension (mm)

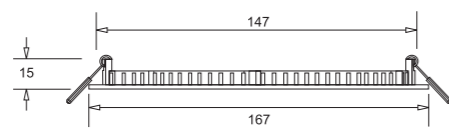

Light Distribution Curve

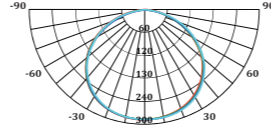

Model : ELX-SLDR-18W



Dimension (mm)

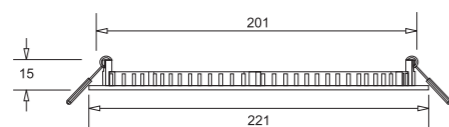

Light Distribution Curve

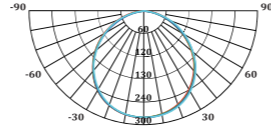

Model : ELX-SLDR-24W



Dimension (mm)

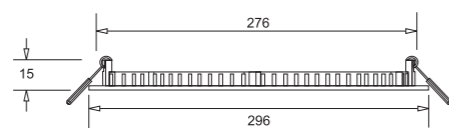

Light Distribution Curve

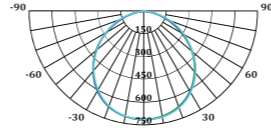

- * Easy maintenance
- Modular LED for easy replacement
- Opening and closing possible of LED module part and power supply part
- Customizable beam angle
- Temperature max 50°



ECO
LUXON
Downlight Ecoluxon
ELX-SLDLS



■ Specification

Daya (W)	Input Voltage	Frequency Amp	LED Efikasi	Total Lumen	CRI	Temperatur Warna	Proteksi	Berat	Material
6W	AC165-265V	50/60Hz	100Lm/W	600Lm	>80Ra	3000K/4000K/6000K	IP20	120gr	Die Casting Aluminium
9W				900Lm				180gr	
12W				1.200Lm				210gr	
18W				1.800Lm				330gr	
24W				2.400Lm				570gr	

Model : ELX-SLDLS-6W



Dimension (mm)

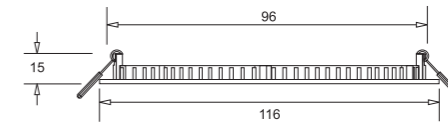

Light Distribution Curve

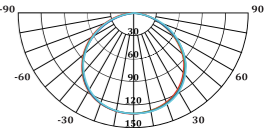

Model : ELX-SLDLS-9W



Dimension (mm)

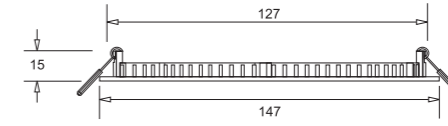

Light Distribution Curve

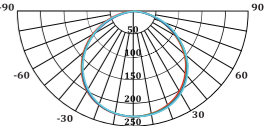

Model : ELX-SLDLS-12W

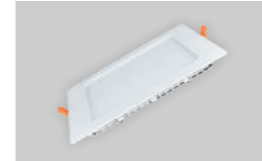

Dimension (mm)

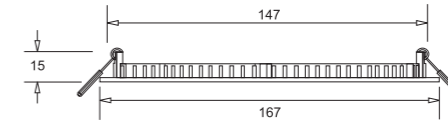

Light Distribution Curve

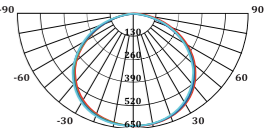

Model : ELX-SLDLS-18W



Dimension (mm)

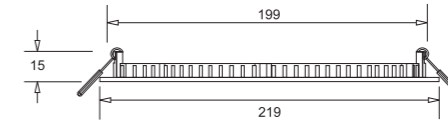

Light Distribution Curve

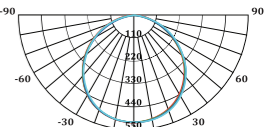

Model : ELX-SLDLS-24W



Dimension (mm)

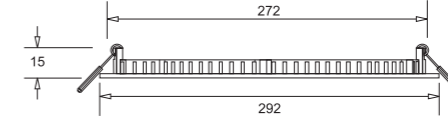

Light Distribution Curve

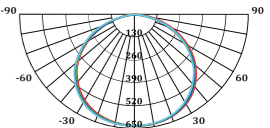

- * Easy maintenance
- Modular LED for easy replacement
- Opening and closing possible of LED module part and power supply part
- Customizable beam angle
- Temperature max 50°



ECO LUXON
Downlight Ecoluxon
ELX-SLDR-OT



Specification

Daya (W)	Input Voltage	Frequency Amp	LED Efikasi	Total Lumen	CRI	Temperatur Warna	Proteksi	Berat	Material
6W 12W 18W 24W	AC100-265V	50/60Hz	100Lm/W	600Lm 1200Lm 1.800Lm 2.400Lm	>80Ra	3000K/6000K	IP20	150gr 240gr 650gr 580gr	Die Casting Aluminium

Model : ELX-SLDR-OT-6W



Dimension (mm)

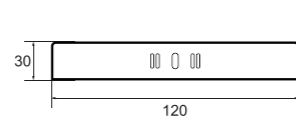
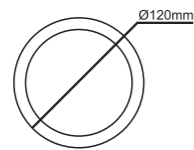

Light Distribution Curve

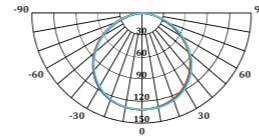

Model : ELX-SLDR-OT-12W



Dimension (mm)

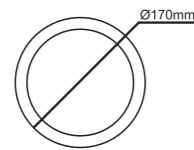

Light Distribution Curve

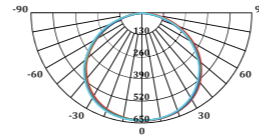

Model : ELX-SLDR-OT-18W



Dimension (mm)

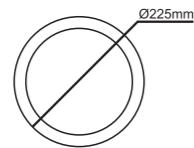

Light Distribution Curve

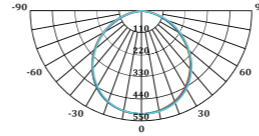

Model : ELX-SLDR-OT-24W



Dimension (mm)

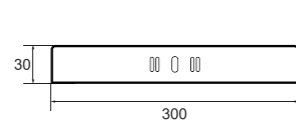
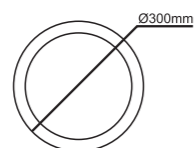

Light Distribution Curve

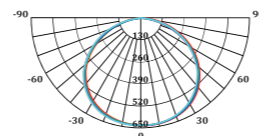

* Easy maintenance
- Modular LED for easy replacement
- Opening and closing possible of LED module part and power supply part
- Customizable beam angle
- Temperature max 50°



ECO LUXON
Downlight Ecoluxon
ELX-SLDLS-OT

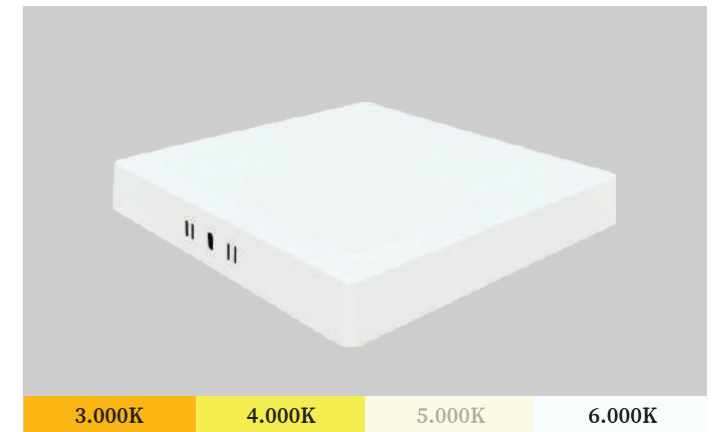

Specification

Daya (W)	Input Voltage	Frequency Amp	LED Efikasi	Total Lumen	CRI	Temperatur Warna	Proteksi	Berat	Material
6W 12W 18W 24W	AC165-265V	50/60Hz	100Lm/W	600Lm 900Lm 1.200Lm 1.800Lm	>80Ra	3000K/4000K/6000K	IP20	120gr 180gr 210gr 330gr	Die Casting Aluminium

Model : ELX-SLDLS-OT-6W



Dimension (mm)

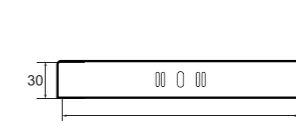
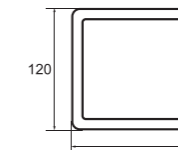

Light Distribution Curve

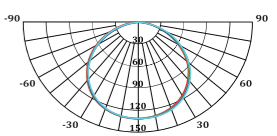

Model : ELX-SLDLS-OT-12W



Dimension (mm)

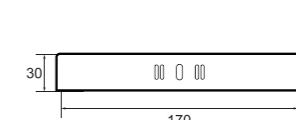
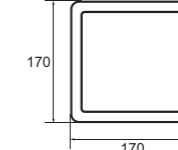

Light Distribution Curve

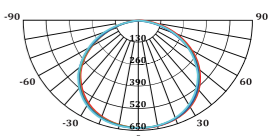

Model : ELX-SLDLS-OT-18W



Dimension (mm)

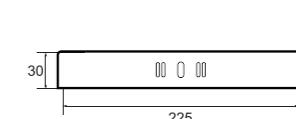
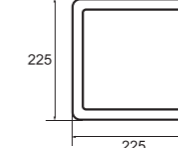

Light Distribution Curve

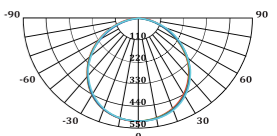

Model : ELX-SLDLS-OT-24W



Dimension (mm)

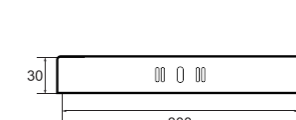
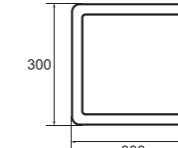

Light Distribution Curve

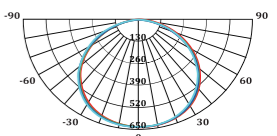

* Easy maintenance
- Modular LED for easy replacement
- Opening and closing possible of LED module part and power supply part
- Customizable beam angle
- Temperature max 50°



ZERON
NEW LIGHT NEW LIFE

Downlight Surface Mounted

ZERN-HY01YS

135
Lm/W



Specification

Daya (W)	Input Voltage	Frequency Amp	LED Efikasi	Total Lumen	CRI	Temperatur Warna	Proteksi	Beam Angle	Material
60W	AC100-240V	50/60Hz	135Lm/W	8.100Lm	>80Ra	3000K/4000K/5000K/6000K	IP65	38°/60°	Die Casting Aluminium
150W	AC100-240V	50/60Hz	135Lm/W	20.250Lm	>80Ra	3000K/4000K/5000K/6000K	IP65	38°/60°	Die Casting Aluminium

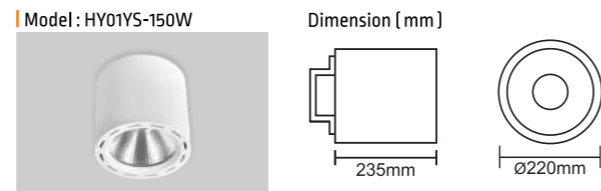
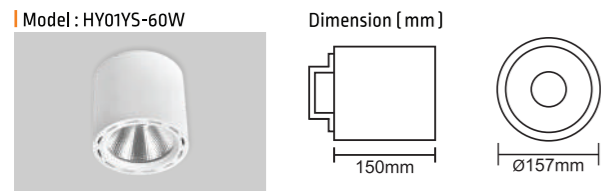

Application



- * Easy maintenance
- Modular LED for easy replacement
- Opening and closing possible of LED module part and power supply part
- Customizable beam angle
- Temperature max 50°



ZERON
NEW LIGHT NEW LIFE

Downlight Surface Mounted

ZERN-J02

100
Lm/W



Specification

Daya (W)	Input Voltage	Frequency Amp	LED Efikasi	Total Lumen	CRI	Temperatur Warna	Proteksi	Beam Angle	Material
12W 20W 30W	AC110-240V	50/60Hz	100Lm/W	1.200Lm 2.000Lm 3.000Lm	>80Ra	3000K/4000K/5000K/6000K	IP20	20°/40°/60°	Die Casting Aluminium



Application



- * Easy maintenance
- Modular LED for easy replacement
- Opening and closing possible of LED module part and power supply part
- Customizable beam angle
- Temperature max 50°



ZERON
NEW LIGHT NEW LIFE

Downlight Surface Mounted

ZERN-HY01YS



■ Specification

Daya (W)	Input Voltage	Frequency Amp	LED Efikasi	Total Lumen	CRI	Temperatur Warna	Proteksi	Beam Angle	Material
10W	AC100-240V	50/60Hz	120Lm/W	1.200Lm	>80Ra Optional (>90Ra, >95Ra)	3000K/4000K/5000K/6000K	IP65	24°/38°/60°	Die Casting Aluminium
30W	AC100-240V	50/60Hz	120Lm/W	3.600Lm	>80Ra Optional (>90Ra, >95Ra)	3000K/4000K/5000K/6000K	IP65	24°/38°/60°	Die Casting Aluminium

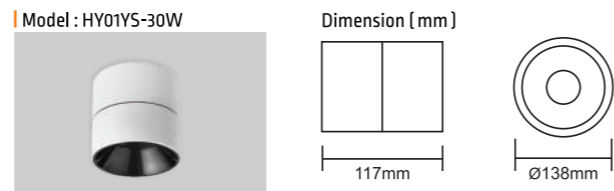
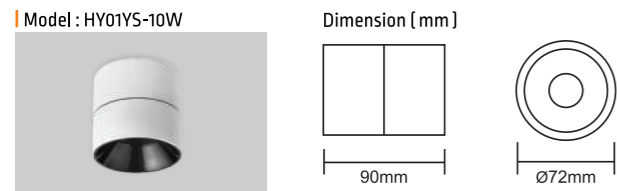

Application

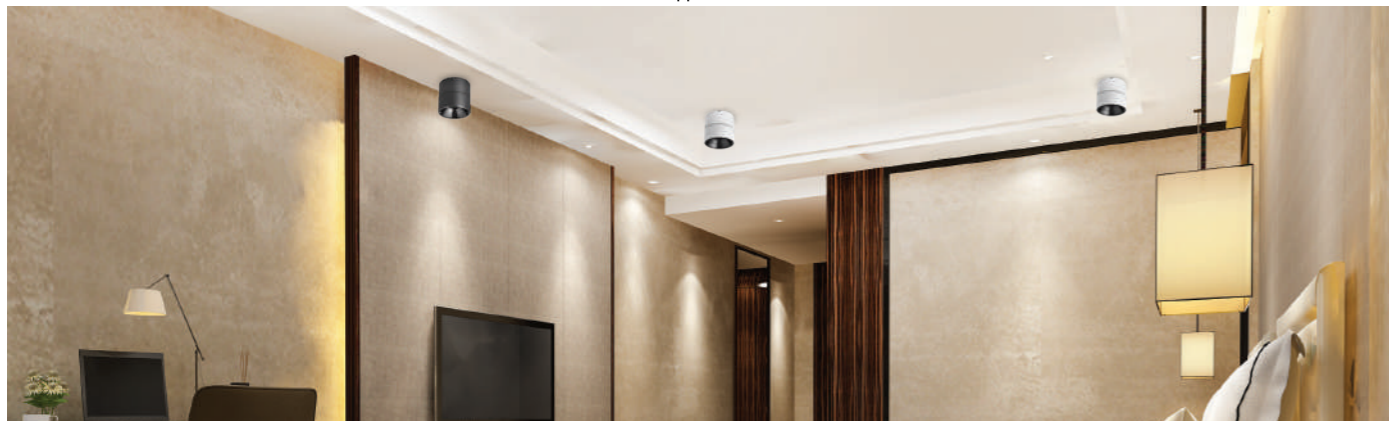

- * Easy maintenance
- Modular LED for easy replacement
- Opening and closing possible of LED module part and power supply part
- Customizable beam angle
- Temperature max 50°



ZERON
NEW LIGHT NEW LIFE

Downlight Surface Mounted

ZERN-J02FSMZ



■ Specification

Daya (W)	Input Voltage	Frequency Amp	LED Efikasi	Total Lumen	CRI	Temperatur Warna	Proteksi	Beam Angle	Material
10W	AC100-277V	50/60Hz	120Lm/W	1.200Lm	>80Ra Optional (>90Ra, >95Ra)	3000K/4000K/5000K/6000K	IP65	20°/40°/60°	Die Casting Aluminium
15W				1.800Lm					
20W				2.400Lm					
30W				3.600Lm					
40W				4.800Lm					
50W				6.000Lm					
60W				7.200Lm					
80W				9.600Lm					

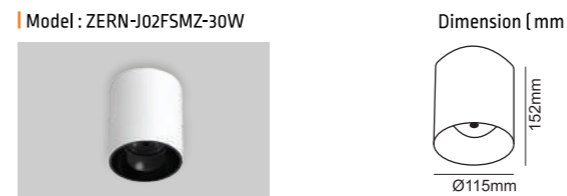
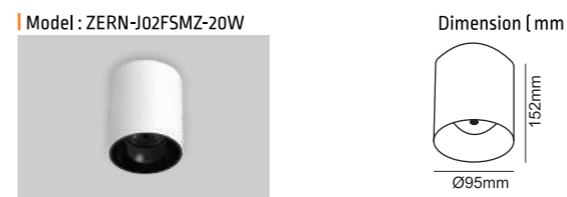
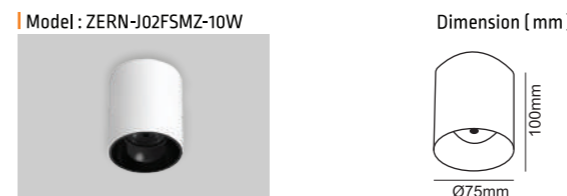

- * Easy maintenance
- Modular LED for easy replacement
- Opening and closing possible of LED module part and power supply part
- Customizable beam angle
- Temperature max 50°





Specification

Daya (W)	Input Voltage	Frequency Amp	LED Efikasi	Total Lumen	CRI	Temperatur Warna	Proteksi	Beam Angle	Material
5W	AC100-240V	50 / 60Hz	90Lm/W	480Lm	>90Ra	3000K/6000K	IP20	45°	Aluminium

Model : ELX-MRAC38-H5W



Dimension (mm)

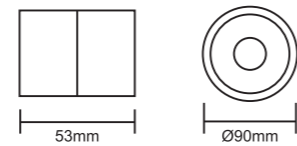

Application

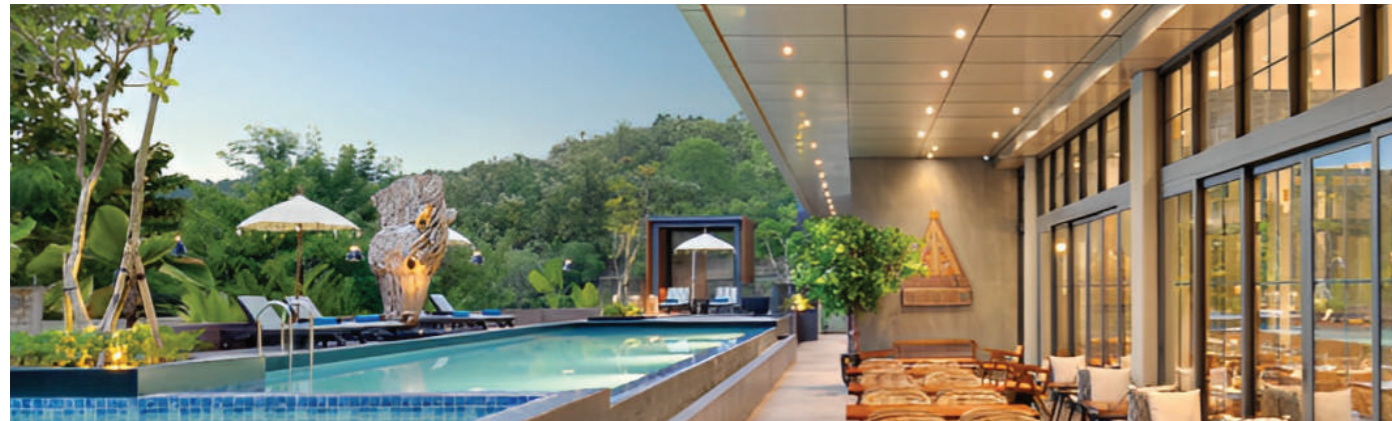

- * Easy maintenance
- Modular LED for easy replacement
- Opening and closing possible of LED module part and power supply part
- Customizable beam angle
- Temperature max 50°



Specification

Daya (W)	Input Voltage	Frequency Amp	LED Efikasi	Total Lumen	CRI	Temperatur Warna	Proteksi	Beam Angle	Material
12W 20W 50W 80W	AC100-240V	50/60Hz	95Lm/W	1.140Lm 1.900Lm 4.750Lm 7.600Lm	>80Ra Optional {>90Ra, >95Ra}	3000K/4000K/5000K/6000K	IP20	15°/24°/38°	Die Casting Aluminium

Model : ZERN-Y01HD-12W



Dimension (mm)

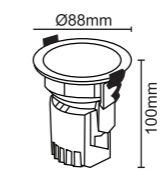

Model : ZERN-Y01HD-50W



Dimension (mm)

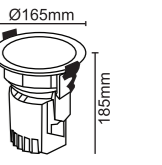

Model : ZERN-Y01HD-20W



Dimension (mm)

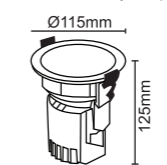

Model : ZERN-Y01HD-80W



Dimension (mm)

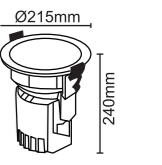

- * Easy maintenance
- Modular LED for easy replacement
- Opening and closing possible of LED module part and power supply part
- Customizable beam angle
- Temperature max 50°



ZERON
NEW LIGHT NEW LIFE

Recessed Downlight

ZERN-H06R



3.000K 4.000K 5.000K 6.000K

■ Specification

Daya (W)	Input Voltage	Frequency Amp	LED Efikasi	Total Lumen	CRI	Temperatur Warna	Proteksi	Beam Angle	Material
10W 20W 30W 40W	AC100-277V	50/60Hz	100Lm/W	1.000Lm 2.000Lm 3.000Lm 4.000Lm	>80Ra Optional (>90Ra, >95Ra)	3000K/4000K/5000K/6000K	IP65	60°	Die Casting Aluminium

Model : ZERN-H06R-10W



Dimension (mm)

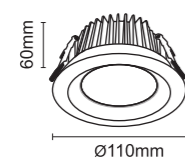

Model : ZERN-H06R-30W



Dimension (mm)

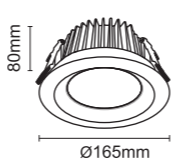

Model : ZERN-H06R-20W



Dimension (mm)

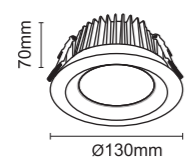

Model : ZERN-H06R-40W



Dimension (mm)

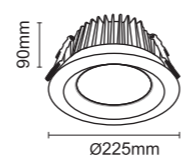

ZERON
NEW LIGHT NEW LIFE

Recessed Downlight

ZERN-H06S

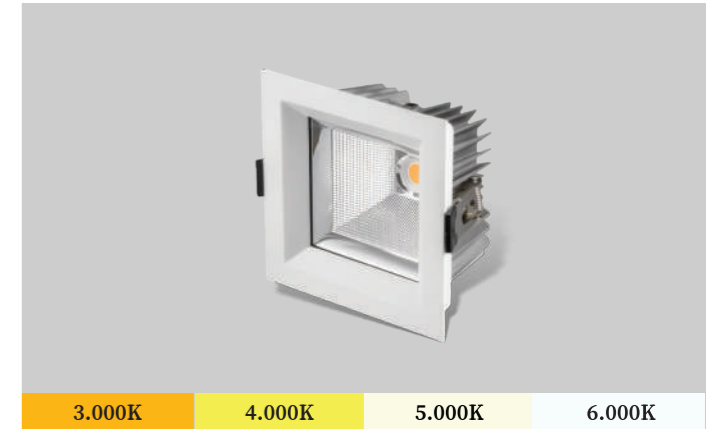

3.000K 4.000K 5.000K 6.000K

■ Specification

Daya (W)	Input Voltage	Frequency Amp	LED Efikasi	Total Lumen	CRI	Temperatur Warna	Proteksi	Beam Angle	Material
10W 20W 30W 40W	AC100-277V	50/60Hz	100Lm/W	1.000Lm 2.000Lm 3.000Lm 4.000Lm	>80Ra Optional (>90Ra, >95Ra)	3000K/4000K/5000K/6000K	IP65	60°	Die Casting Aluminium

Model : ZERN-H06S-10W



Dimension (mm)

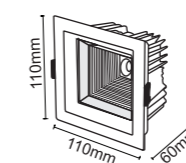

Model : ZERN-H06S-30W



Dimension (mm)

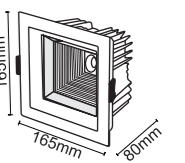

Model : ZERN-H06S-20W



Dimension (mm)

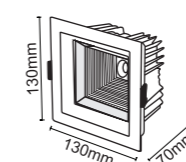

Model : ZERN-H06S-40W



Dimension (mm)

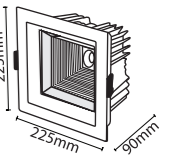

* Easy maintenance
- Modular LED for easy replacement
- Opening and closing possible of LED module part and power supply part
- Customizable beam angle
- Temperature max 50°



* Easy maintenance
- Modular LED for easy replacement
- Opening and closing possible of LED module part and power supply part
- Customizable beam angle
- Temperature max 50°



ZERON

NEW LIGHT NEW LIFE

Recessed Downlight

ZERN-001LP

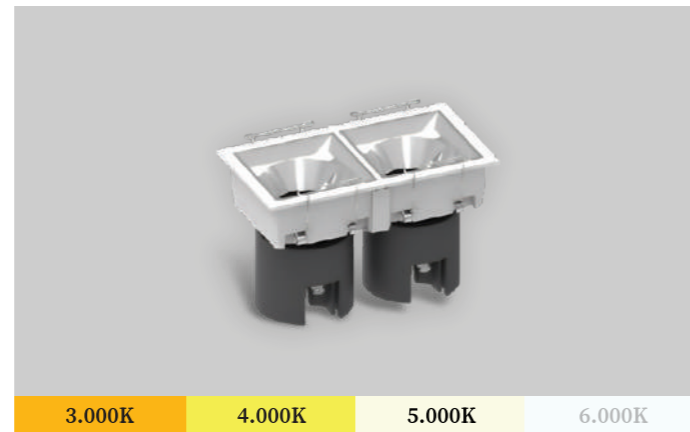

3.000K 4.000K 5.000K 6.000K

Specification

Daya (W)	Input Voltage	Frequency Amp	LED Efikasi	Total Lumen	CRI	Temperatur Warna	Proteksi	Beam Angle	Material
7W	AC100-240V	50/60Hz	90Lm/W	630Lm	>80Ra Optional (>90Ra, >95Ra)	3000K/4000K/5000K	IP20	15°/24°/36°	Aluminium
12W				1.080Lm					
14W				1.260Lm					
20W				1.800Lm					
24W				2.160Lm					
40W				3.600Lm					

Model : ZERN-001LP-7W*1



Dimension (mm)

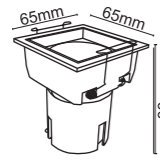

Model : ZERN-001LP-7W*2



Dimension (mm)

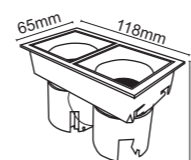

Model : ZERN-001LP-7W*3

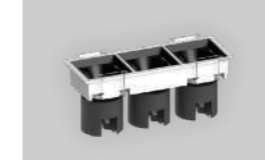

Dimension (mm)

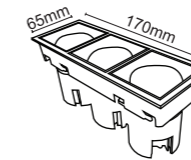

Model : ZERN-001LP-7W*4



Dimension (mm)

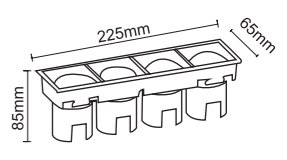

Model : ZERN-001LP-12W*1



Dimension (mm)

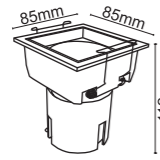

Model : ZERN-001LP-12W*2



Dimension (mm)

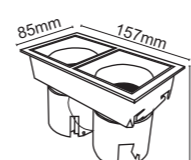

Model : ZERN-001LP-12W*3

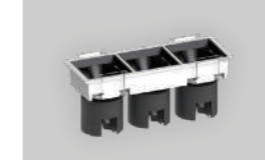

Dimension (mm)

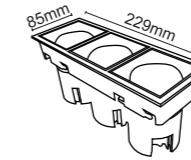

Model : ZERN-001LP-12W*4



Dimension (mm)

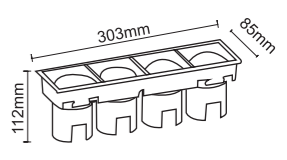

Model : ZERN-001LP-20W*1



Dimension (mm)

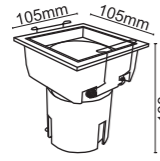

Model : ZERN-001LP-20W*2



Dimension (mm)

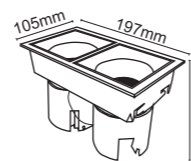

Model : ZERN-001LP-20W*3



Dimension (mm)

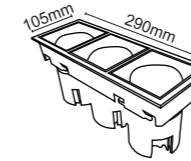

Model : ZERN-001LP-20W*4



Dimension (mm)

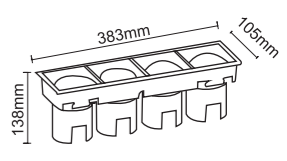

- * Easy maintenance
- Modular LED for easy replacement
- Opening and closing possible of LED module part and power supply part
- Customizable beam angle
- Temperature max 50°



- * Easy maintenance
- Modular LED for easy replacement
- Opening and closing possible of LED module part and power supply part
- Customizable beam angle
- Temperature max 50°



ZERON
NEW LIGHT NEW LIFE

Recessed Downlight

ZERN-Y01KZR



■ Specification

Daya (W)	Input Voltage	Frequency Amp	LED Efikasi	Total Lumen	CRI	Temperatur Warna	Proteksi	Beam Angle	Material
8W	AC165-265V	50/60Hz	100Lm/W	800Lm	>80Ra Optional (>90Ra, >95Ra)	3000K/4000K/6000K	IP20	15°/24°/36°	Die Casting Aluminium
12W				1.200Lm					
15W				1.500Lm					
16W				1.600Lm					
24W				2.400Lm					
30W				3.000Lm					

Model : ZERN-Y01KZR-8W*1



Dimension (mm)

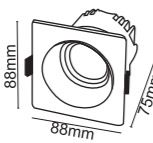

Model : ZERN-Y01KZR-8W*2



Dimension (mm)

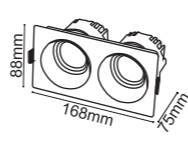

Model : ZERN-Y01KZR-8W*3



Dimension (mm)

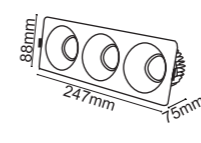

Model : ZERN-Y01KZR-8W*4



Dimension (mm)

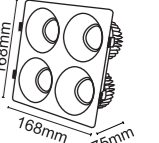

Model : ZERN-Y01KZR-12W*1



Dimension (mm)

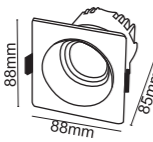

Model : ZERN-Y01KZR-12W*2



Dimension (mm)

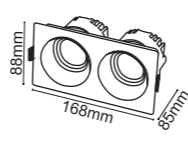

Model : ZERN-Y01KZR-12W*3



Dimension (mm)

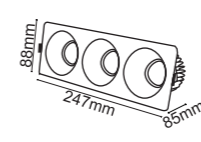

Model : ZERN-Y01KZR-12W*4



Dimension (mm)

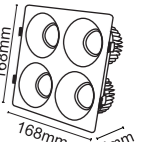

Model : ZERN-Y01KZR-15W*1



Dimension (mm)

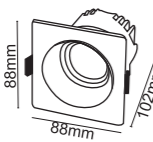

Model : ZERN-Y01KZR-15W*2



Dimension (mm)

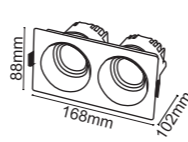

Model : ZERN-Y01KZR-15W*3



Dimension (mm)

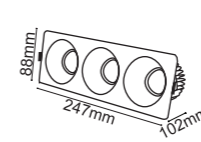

Model : ZERN-Y01KZR-15W*4



Dimension (mm)

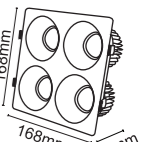

* Easy maintenance
 - Modular LED for easy replacement
 - Opening and closing possible of LED module part and power supply part
 - Customizable beam angle
 - Temperature max 50°



ZERON
NEW LIGHT NEW LIFE

Recessed Downlight

ZERN-Y01KZR

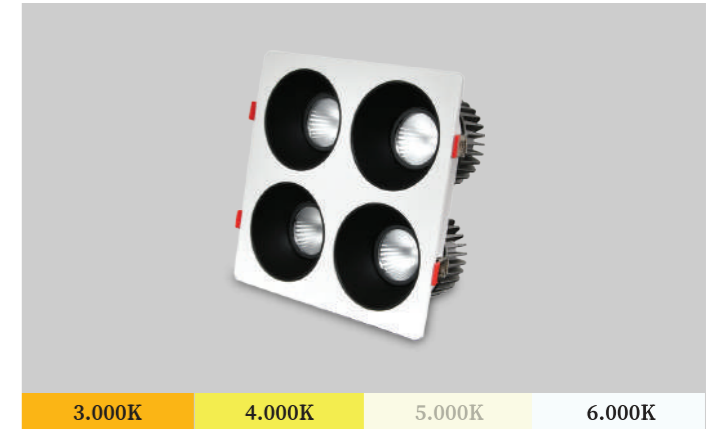

■ Specification

Daya (W)	Input Voltage	Frequency Amp	LED Efikasi	Total Lumen	CRI	Temperatur Warna	Proteksi	Beam Angle	Material
24W	AC165-265V	50/60Hz	100Lm/W	2.400Lm	>80Ra Optional (>90Ra, >95Ra)	3000K/4000K/6000K	IP20	15°/24°/36°	Die Casting Aluminium
32W				3.200Lm					
36W				3.600Lm					
45W				4.500Lm					
48W				4.800Lm					
60W				6.000Lm					

* Easy maintenance
 - Modular LED for easy replacement
 - Opening and closing possible of LED module part and power supply part
 - Customizable beam angle
 - Temperature max 50°



ZERON
NEW LIGHT NEW LIFE

Recessed Downlight

ZERN-J02FSS

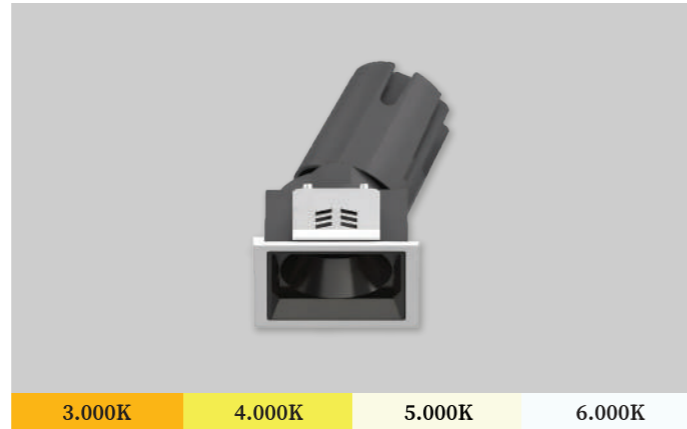

■ Specification

Daya (W)	Input Voltage	Frequency Amp	LED Efikasi	Total Lumen	CRI	Temperatur Warna	Proteksi	Beam Angle	Material
7W 10W 12W 18W 20W 30W	AC100-277V	50/60Hz	110Lm/W	770Lm 1.100Lm 1.320Lm 1.980Lm 2.200Lm 3.300Lm	>80Ra Optional (>90Ra, >95Ra)	3000K/4000K/5000K/6000K	IP65	15°/24°/38°/60°	Die Casting Aluminium



* Easy maintenance
- Modular LED for easy replacement
- Opening and closing possible of LED module part and power supply part
- Customizable beam angle
- Temperature max 50°



ZERON
NEW LIGHT NEW LIFE

Recessed Downlight

ZERN-J02FSS



■ Specification

Daya (W)	Input Voltage	Frequency Amp	LED Efikasi	Total Lumen	CRI	Temperatur Warna	Proteksi	Beam Angle	Material
14W 20W 24W 36W 40W 60W	AC100-277V	50/60Hz	110Lm/W	1.540Lm 2.200Lm 2.640Lm 2.640Lm 4.400Lm 6.600Lm	>80Ra Optional (>90Ra, >95Ra)	3000K/4000K/5000K/6000K	IP65	15°/24°/38°/60°	Die Casting Aluminium

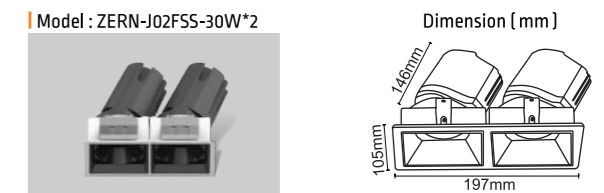
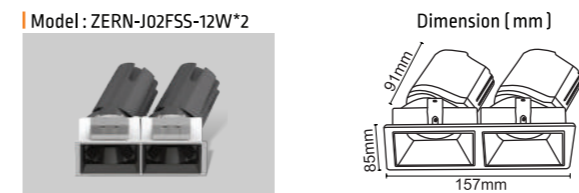
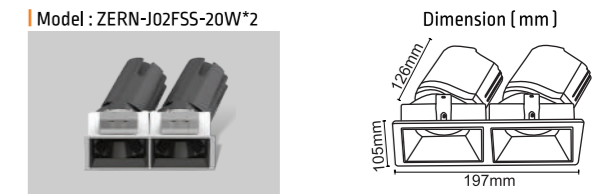
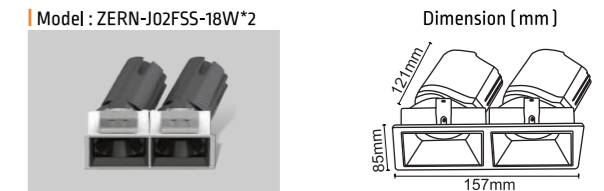
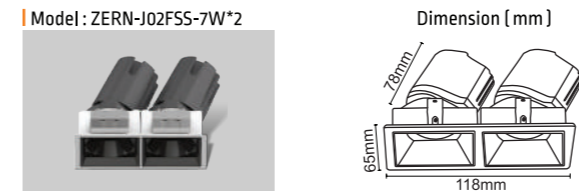

* Easy maintenance
- Modular LED for easy replacement
- Opening and closing possible of LED module part and power supply part
- Customizable beam angle
- Temperature max 50°



ZERON
NEW LIGHT NEW LIFE

Recessed Downlight

ZERN-J02FSS

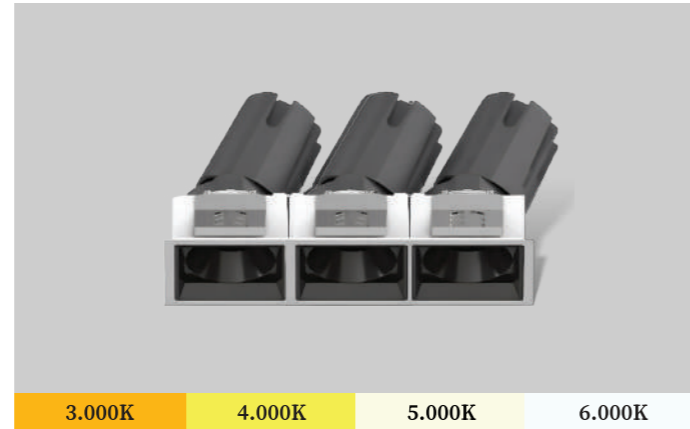

■ Specification

Daya (W)	Input Voltage	Frequency Amp	LED Efikasi	Total Lumen	CRI	Temperatur Warna	Proteksi	Beam Angle	Material
21W	AC100-277V	50/60Hz	110Lm/W	2.310Lm	>80Ra Optional (>90Ra, >95Ra)	3000K/4000K/5000K/6000K	IP65	15°/24°/38°/60°	Die Casting Aluminium
30W				3.300Lm					
36W				3.960Lm					
54W				5.940Lm					
60W				6.600Lm					
90W				9.900Lm					

Model : ZERN-J02FSS-7W*3

Dimension (mm)

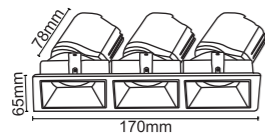

Model : ZERN-J02FSS-18W*3

Dimension (mm)

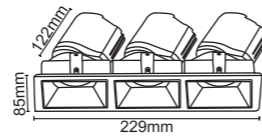

Model : ZERN-J02FSS-7W*4

Dimension (mm)

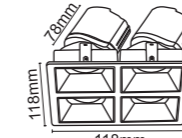

Model : ZERN-J02FSS-18W*4

Dimension (mm)

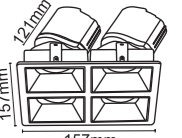

Model : ZERN-J02FSS-10W*3

Dimension (mm)

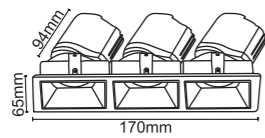

Model : ZERN-J02FSS-20W*3

Dimension (mm)

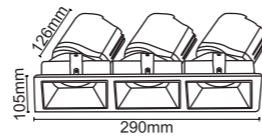

Model : ZERN-J02FSS-10W*4

Dimension (mm)

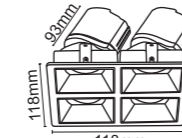

Model : ZERN-J02FSS-20W*4

Dimension (mm)

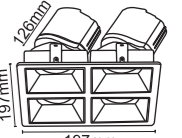

Model : ZERN-J02FSS-12W*3

Dimension (mm)

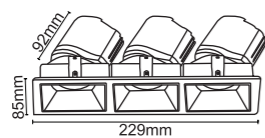

Model : ZERN-J02FSS-30W*3

Dimension (mm)

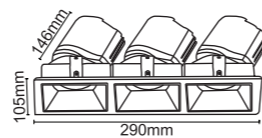

Model : ZERN-J02FSS-12W*4

Dimension (mm)

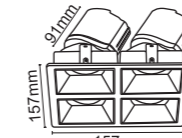

Model : ZERN-J02FSS-30W*4

Dimension (mm)

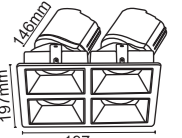

- * Easy maintenance
- Modular LED for easy replacement
- Opening and closing possible of LED module part and power supply part
- Customizable beam angle
- Temperature max 50°



- * Easy maintenance
- Modular LED for easy replacement
- Opening and closing possible of LED module part and power supply part
- Customizable beam angle
- Temperature max 50°



ZERON
NEW LIGHT NEW LIFE

Recessed Downlight

ZERN-H01GS

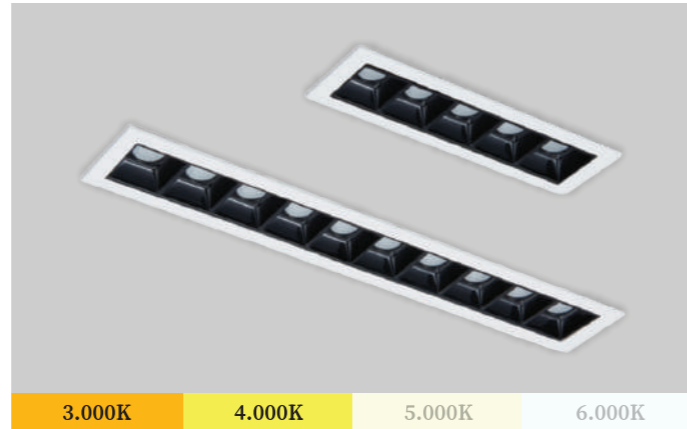

Specification

Daya (W)	Input Voltage	Frequency Amp	LED Efikasi	Total Lumen	CRI	Temperatur Warna	Proteksi	Beam Angle	Material
4W 6W 10W 16W 20W 30W	AC110-240V	50/60Hz	100Lm/W	400Lm 600Lm 1.000Lm 1.600Lm 2.000Lm 3.000Lm	>80Ra Optional (>90Ra, >95Ra)	3000K/4000K	IP20	15°/30°/45°	Aluminium

Model : ZERN-H01GS-2W*2

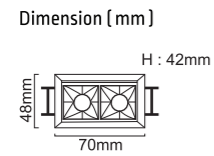

Model : ZERN-H01GS-2W*8

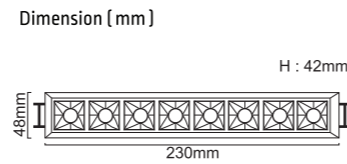

Model : ZERN-H01GS-2W*3

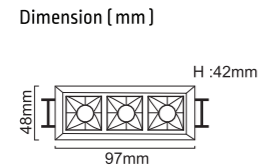

Model : ZERN-H01GS-2W*10

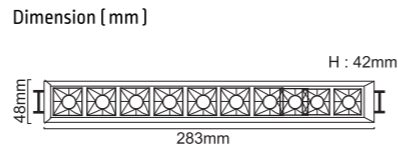

Model : ZERN-H01GS-2W*5

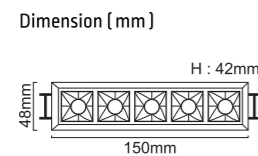

Model : ZERN-H01GS-2W*15

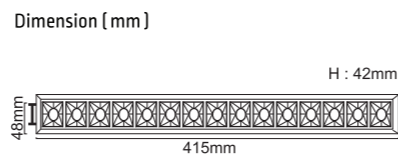
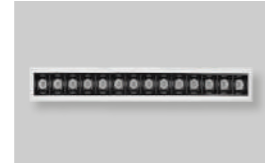

- * Easy maintenance
- Modular LED for easy replacement
- Opening and closing possible of LED module part and power supply part
- Customizable beam angle
- Temperature max 50°



ZERON
NEW LIGHT NEW LIFE

Recessed Downlight

ZERN-S02CX

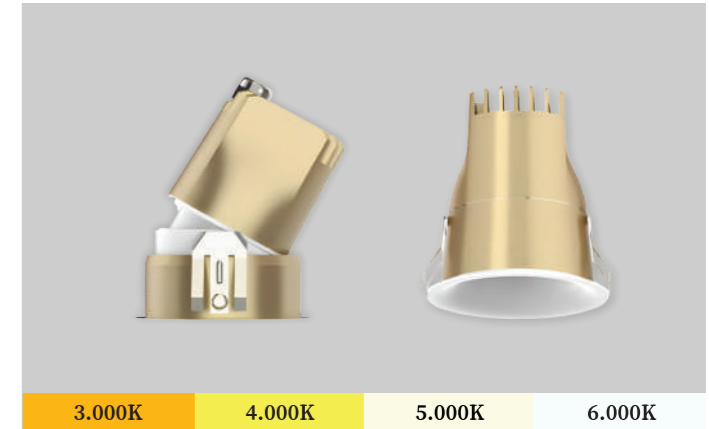

Specification

Daya (W)	Input Voltage	Frequency Amp	LED Efikasi	Total Lumen	CRI	Temperatur Warna	Proteksi	Beam Angle	Material
5W 7W 9W 12W 15W	AC100-277V	50/60Hz	95Lm/W	475Lm 665Lm 855Lm 1.140Lm 1.425Lm	>80Ra Optional (>90Ra, >95Ra)	3000K/4000K/5000K/6000K	IP20	15°/24°/36°/60°	Die Casting Aluminium

Model : ZERN-S02CX-5W

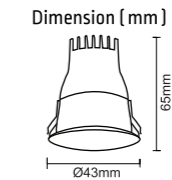

Light Distribution Curve

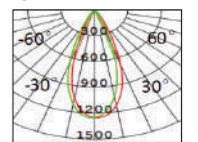

Model : ZERN-S02CX-7W

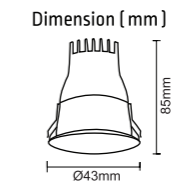

Light Distribution Curve

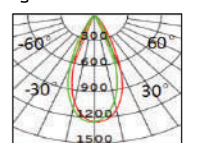

Model : ZERN-S02CX-9W

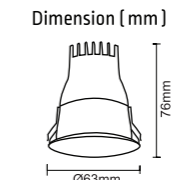

Light Distribution Curve

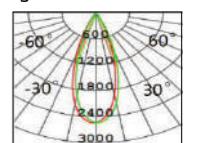

Model : ZERN-S02CX-12W

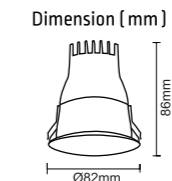

Light Distribution Curve

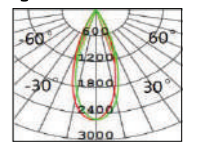

Model : ZERN-S02CX-15W

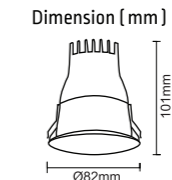

Light Distribution Curve

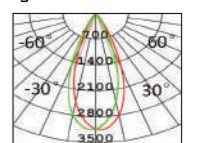

- * Easy maintenance
- Modular LED for easy replacement
- Opening and closing possible of LED module part and power supply part
- Customizable beam angle
- Temperature max 50°



ZERON
NEW LIGHT NEW LIFE

Recessed Downlight

ZERN-Y01KZS



3.000K 4.000K 5.000K 6.000K

■ Specification

Daya (W)	Input Voltage	Frequency Amp	LED Efikasi	Total Lumen	CRI	Temperatur Warna	Proteksi	Material
12W 24W 36W 48W	AC110-240V	50/60Hz	100Lm/W	1.200Lm 2.400Lm 3.600Lm 4.800Lm	>80Ra Optional {>90Ra, >95Ra}	3000K/4000K/5000K	IP20	Aluminium

Model : ZERN-701KZS-12*1



Dimension (mm)

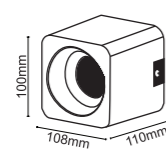

Model : ZERN-Y01KZS-12W*3



Dimension (mm)

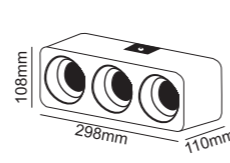

Model : ZERN-Y01KZS-12W*2



Dimension (mm)

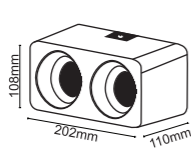

Model : ZERN-Y01KZS-12W*4



Dimension (mm)

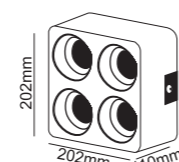

* Easy maintenance
- Modular LED for easy replacement
- Opening and closing possible of LED module part and power supply part
- Customizable beam angle
- Temperature max 50°



ECO
LUXON

Recessed Downlight

ELX-W02-SDR/SDS

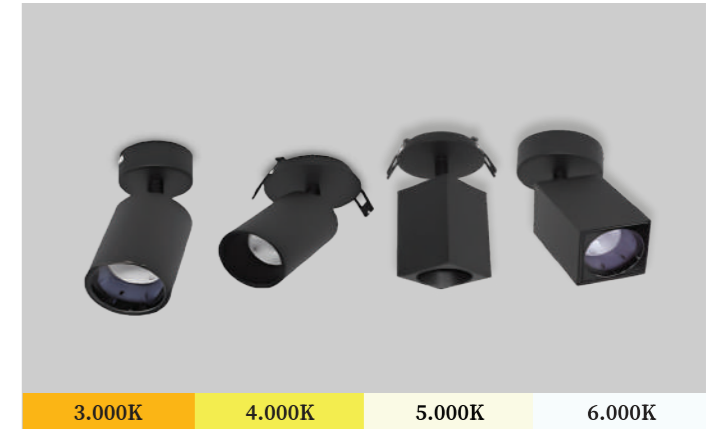

3.000K 4.000K 5.000K 6.000K

■ Specification

Daya (W)	Input Voltage	Frequency Amp	LED Efikasi	Total Lumen	CRI	Temperatur Warna	Proteksi	Beam Angle	Material
10W 20W 25W	AC100-240V	50/60Hz	90Lm/W	900Lm 1.800Lm 2.250Lm	>80Ra Optional {>90Ra, >95Ra}	3000K/4000K/5000K/6000K	IP20	3°/5°/15°/24°/36°	Die Casting Aluminium

Model : ELX-SDR-10W



Dimension (mm)



Model : ELX-SDS-10W



Dimension (mm)

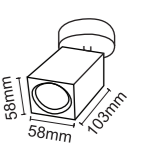

Model : ELX-SDR-20W



Dimension (mm)



Model : ELX-SDS-20W



Dimension (mm)

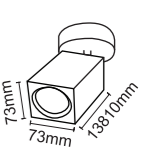

Model : ELX-SDR-25W



Dimension (mm)



Model : ELX-SDS-25W



Dimension (mm)

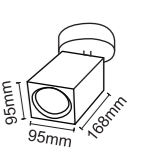

Optional Application



* Easy maintenance
- Modular LED for easy replacement
- Opening and closing possible of LED module part and power supply part
- Customizable beam angle
- Temperature max 50°



ECO **LUXON**
Recessed Downlight
ELX -W01-XSD



3.000K 4.000K 5.000K 6.000K

■ Specification

Daya (W)	Input Voltage	Frequency Amp	LED Efikasi	Total Lumen	CRI	Temperatur Warna	Proteksi	Beam Angle	Material
5W 7W 9W 12W	AC100-240V	50/60Hz	85Lm/W	425Lm 595Lm 765Lm 1.020Lm	>80Ra Optional (>90Ra, >95Ra)	3000K/4000K/5000K/6000K	IP20	15°/24°/36°	Aluminium Housing

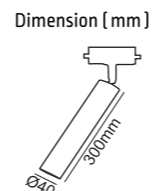
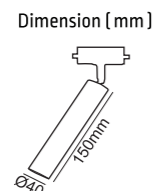
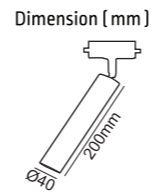
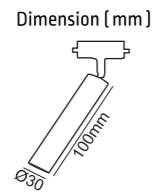

* Easy maintenance
- Modular LED for easy replacement
- Opening and closing possible of LED module part and power supply part
- Customizable beam angle
- Temperature max 50°



ECO **LUXON**
Track Light Ecoluxon
ELX-JKTLJ610



3.000K 4.000K 5.000K 6.000K

■ Specification

Daya (W)	Input Voltage	Frequency Amp	LED Efikasi	Total Lumen	CRI	Temperatur Warna	Beam Angle	Berat	Material
10W 20W 30W	AC180-240V	50/60Hz	100Lm/W	1.000Lm 2.000Lm 3.000Lm	>80Ra	3000K/4000K/6000K	30°	180gr 300gr 400gr	Die Casting Aluminium

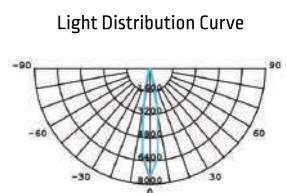
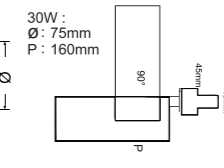
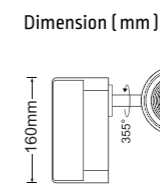
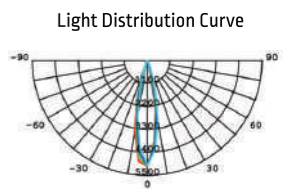
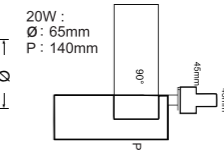
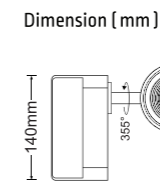
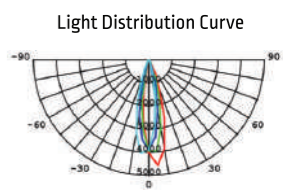
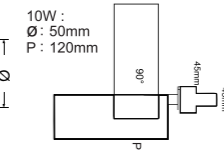
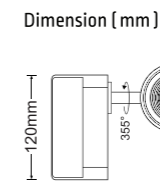

* Easy maintenance
- Modular LED for easy replacement
- Opening and closing possible of LED module part and power supply part
- Customizable beam angle
- Temperature max 50°



ECO **LUXON**
Moisture Proof Ecoluxon
ELX-ECDL-MPF



■ **Specification**

Daya (W)	Input Voltage	Frequency Amp	LED Efikasi	Total Lumen	CRI	Temperatur Warna	Proteksi	Berat	Material
14W	AC100-265V	50/60Hz	70Lm/W	980Lm	>80Ra	3000K/6000K	IP65	560gr	Aluminium + Glass
18W				1.260Lm				700gr	
24W				1.680Lm				900gr	

Model : ELX-ECDL-MPF-14W



Dimension (mm)

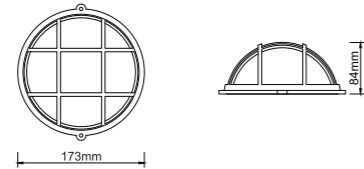

Light Distribution Curve

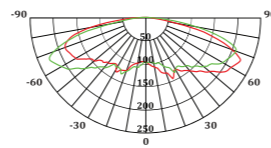

Model : ELX-ECDL-MPF-18W



Dimension (mm)

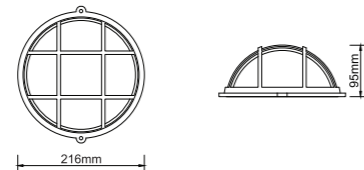

Light Distribution Curve

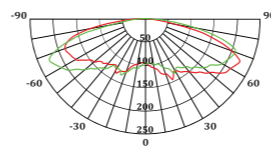

Model : ELX-ECDL-MPF-24W



Dimension (mm)

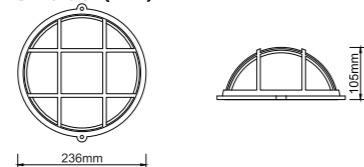

Light Distribution Curve

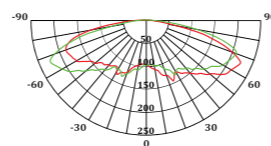

- * Easy maintenance
- Modular LED for easy replacement
- Opening and closing possible of LED module part and power supply part
- Customizable beam angle
- Temperature max 50°



ECO **LUXON**
Aluminium Radiator
ELX-AR111



■ **Specification**

Daya (W)	Input Voltage	Frequency Amp	LED Efikasi	Total Lumen	CRI	Temperatur Warna	Proteksi	Material
10W	AC100-240V	50/60Hz	90Lm/W	900Lm	>80Ra	3000K/4000K/5000K/6000K	IP20	Die Casting Aluminium
20W				1.800Lm				Die Casting Aluminium

Model : ELX-AR111-10W



Dimension (mm)

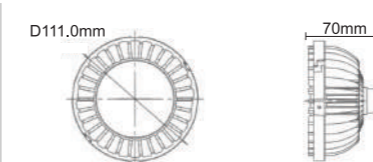

Model : ELX-AR111-20W



Dimension (mm)

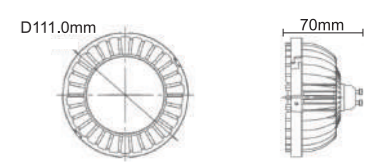

Application



- * Easy maintenance
- Modular LED for easy replacement
- Opening and closing possible of LED module part and power supply part
- Customizable beam angle
- Temperature max 50°



ECO
LUXON
MR16 Ecoluxon
ELX-MRAC38 / MRDC38



3.000K 4.000K 5.000K 6.000K

Specification

Daya (W)	Input Voltage	Frequency Amp	LED Efikasi	Total Lumen	CRI	Temperatur Warna	Beam Angle	Berat	Material
5W	DC 12V, AC 100-240V	50/60Hz	85Lm/W	425Lm	>80Ra	3000K/6000K	38°	58.5gr, 29gr	Die Casting Aluminium

Model : ELX-MRAC38-5W
ELX-MRDC38-5W



Dimension [mm]

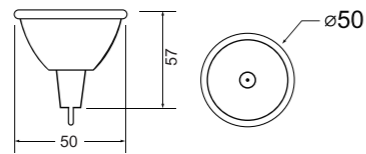

Light Distribution Curve

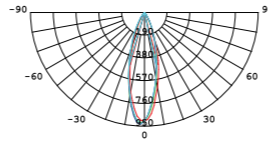

Application

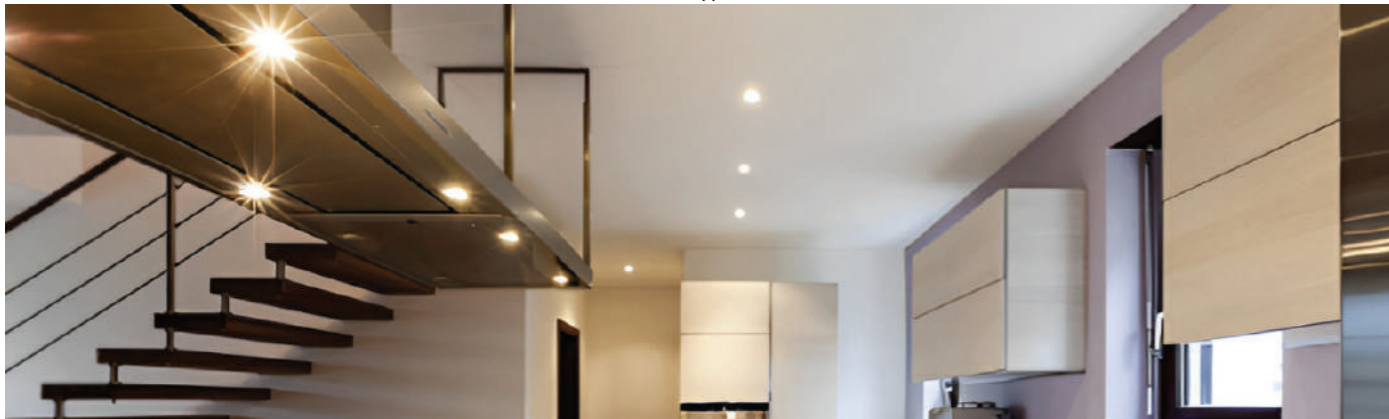

- * Easy maintenance
- Modular LED for easy replacement
- Opening and closing possible of LED module part and power supply part
- Customizable beam angle
- Temperature max 50°



ECO
LUXON
MR16 ECOLUXON
ELX-MRDC



3.000K 4.000K 5.000K 6.000K

Specification

Daya (W)	Input Voltage	Frequency Amp	LED Efikasi	Total Lumen	CRI	Temperatur Warna	Beam Angle	Berat	Material
6W	DC 12V	50/60Hz	100Lm/W	600Lm	>90Ra	3000K/4000K/6000K	15°/24°	43.5gr 40gr	Die Casting CNC Aluminium

Model : ELX-MRDC15HQ-6W



Dimension [mm]

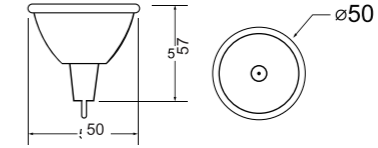

Light Distribution Curve

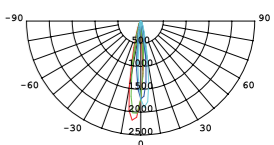

Model : ELX-MRDC24HQ-6W



Dimension [mm]

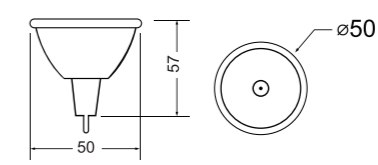

Light Distribution Curve

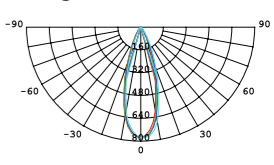

- * Easy maintenance
- Modular LED for easy replacement
- Opening and closing possible of LED module part and power supply part
- Customizable beam angle
- Temperature max 50°



ECO
LUXON
Bulb Ecoluxon
ELX-BL



■ Specification

Daya (W)	Input Voltage	Frequency Amp	LED Efikasi	Total Lumen	CRI	Temperatur Warna	Proteksi	Berat	Material
5W	AC165-265V	50/60Hz	120Lm/W	600Lm	>80Ra	3000K/4000K/6000K	IP20	21gr	Die Casting Aluminium
7W				840Lm				27gr	
9W				1.080Lm				29gr	
12W				1.440Lm				36.5gr	
18W				2.160Lm				50gr	

Model : ELX-BL-5W



Dimension (mm)

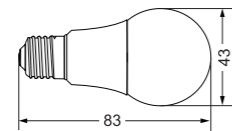

Light Distribution Curve

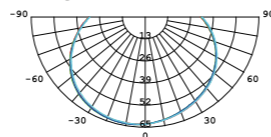

Model : ELX-BL-7W



Dimension (mm)

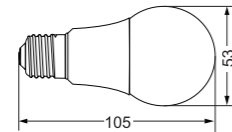

Light Distribution Curve

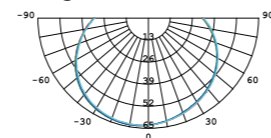

Model : ELX-BL-9W



Dimension (mm)

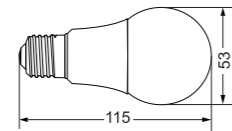

Light Distribution Curve

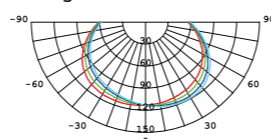

Model : ELX-BL-12W



Dimension (mm)

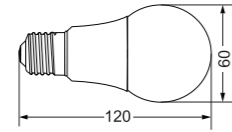

Light Distribution Curve

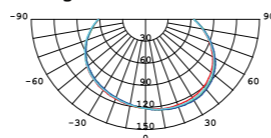

Model : ELX-BL-18W



Dimension (mm)

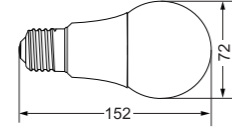

Light Distribution Curve

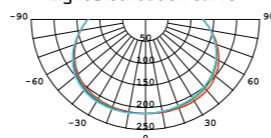

- * Easy maintenance
- Modular LED for easy replacement
- Opening and closing possible of LED module part and power supply part
- Customizable beam angle
- Temperature max 50°



ECO
LUXON
PAR30 Ecoluxon
ELX-LSP359



■ Specification

Daya (W)	Input Voltage	Frequency Amp	LED Efikasi	Total Lumen	CRI	Temperatur Warna	Beam Angle	Berat	Material
30W	AC180-240V	50/60Hz	100Lm/W	3.000Lm	>90Ra	3000K/4000K/6000K	15°/24°/36°	394gr	Die Casting Aluminium

Model : ELX-LSP359-30W



Dimension (mm)

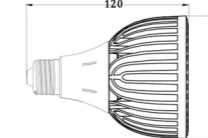

Light Distribution Curve

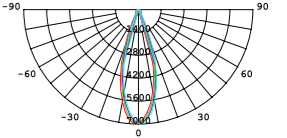

Model : ELX-LSP359TJFC-30W



Dimension (mm)

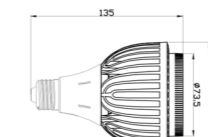

Light Distribution Curve

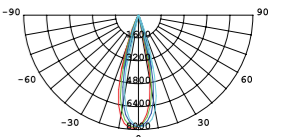

- * Easy maintenance
- Modular LED for easy replacement
- Opening and closing possible of LED module part and power supply part
- Customizable beam angle
- Temperature max 50°



ECO
LUXON
Strip Light Ecoluxon
ELX-INST-COB

100
lm/W

90
CRI



3.000K 4.000K 5.000K 6.000K

Specification

Daya (W)	Input Voltage	Frequency Amp	LED Efikasi	Total Lumen	CRI	Temperatur Warna	Proteksi	Unit	Material
8W 11W 14W	DC 12V	50/60Hz	100Lm/W	800Lm 1.100Lm 1.400Lm	>90Ra	3000K/4000K/6000K	IP20	5 Meter/Roll	Polymide

Model : COB

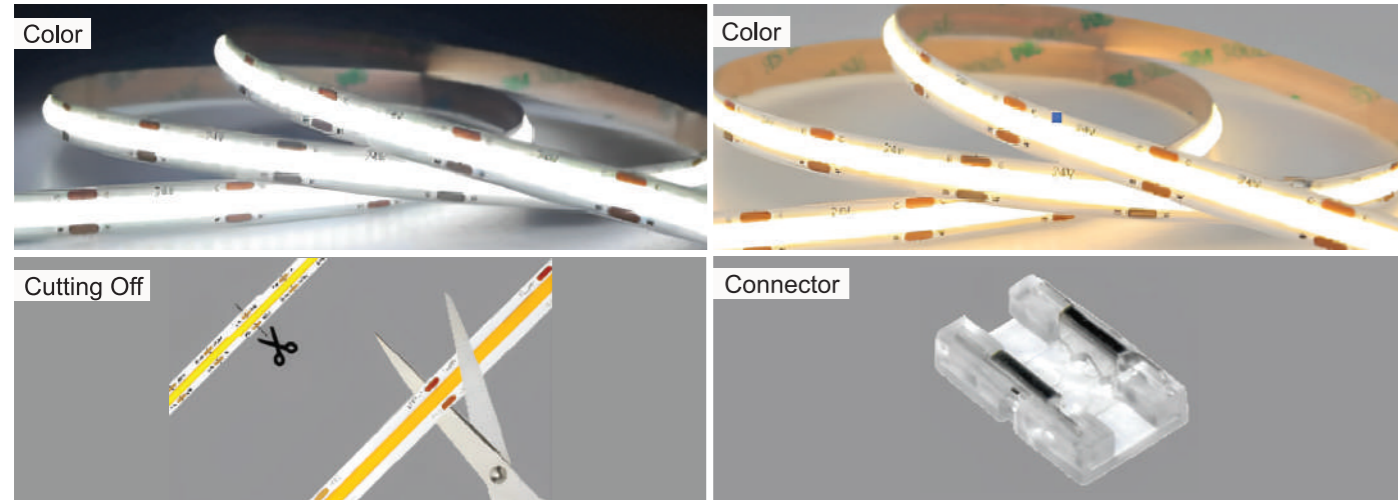

Application

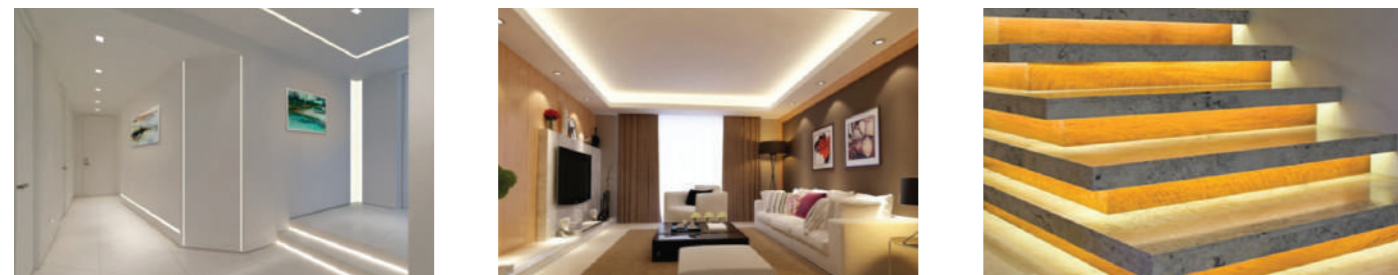

- * Easy maintenance
- Modular LED for easy replacement
- Opening and closing possible of LED module part and power supply part
- Customizable beam angle
- Temperature max 50°



ECO
LUXON
Flat Light Ecoluxon
ELX-FLTB-ECOFLPJ

120
lm/W

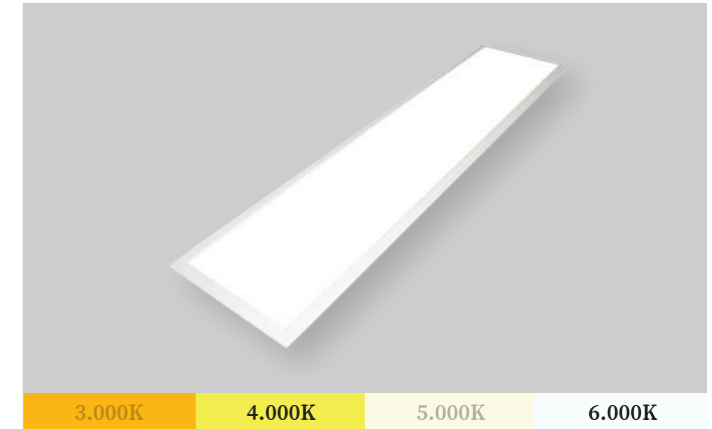

3.000K 4.000K 5.000K 6.000K

Specification

Daya (W)	Input Voltage	Frequency Amp	LED Efikasi	Total Lumen	CRI	Temperatur Warna	Proteksi	Berat	Material
36W 48W	AC170-265V	50/60Hz	120Lm/W	4.320Lm 5.760Lm	>80Ra	4000K/6000K	IP20	2.4kg 2.5kg	Die Casting Aluminium

External Type



Dimension (mm)

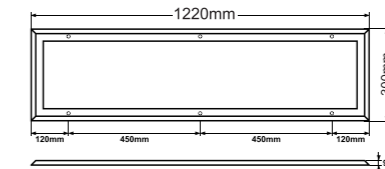

Light Distribution Curve

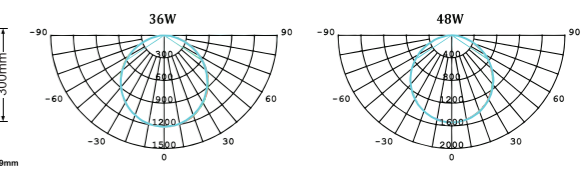

Internal Type



Dimension (mm)

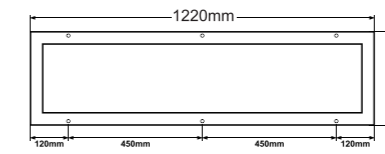

Light Distribution Curve

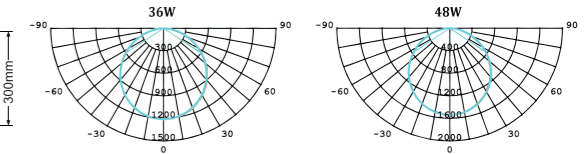

Thick Type



Dimension (mm)

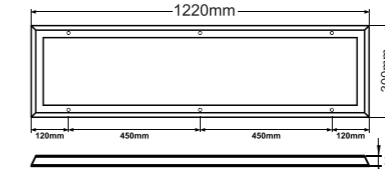

Light Distribution Curve

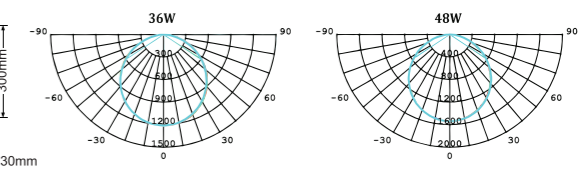

- * Easy maintenance
- Modular LED for easy replacement
- Opening and closing possible of LED module part and power supply part
- Customizable beam angle
- Temperature max 50°



ECO
LUXON
Flat Light Ecoluxon
ELX-FLT-ECOFLKT

120
lm/W



Specification

Daya (W)	Input Voltage	Frequency Amp	LED Efikasi	Total Lumen	CRI	Temperatur Warna	Proteksi	Berat	Material
36W	AC170-265V	50/60Hz	120Lm/W	4.320Lm	>80Ra	4000K/6000K	IP20	2kg	Die Casting Aluminium
48W	AC170-265V	50/60Hz	120Lm/W	5.760Lm	>80Ra	4000K/6000K	IP20	2kg	Die Casting Aluminium

Dimension (mm)

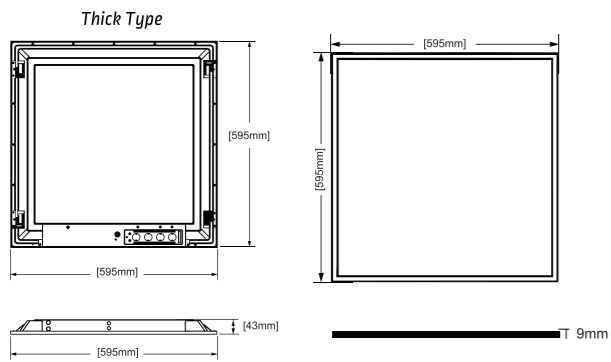

Light Distribution Curve

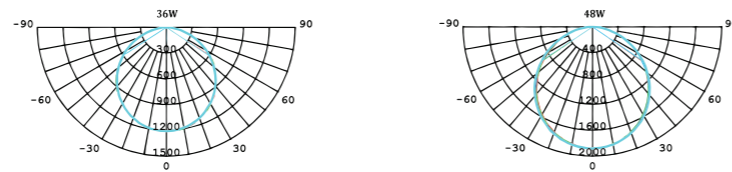

Application

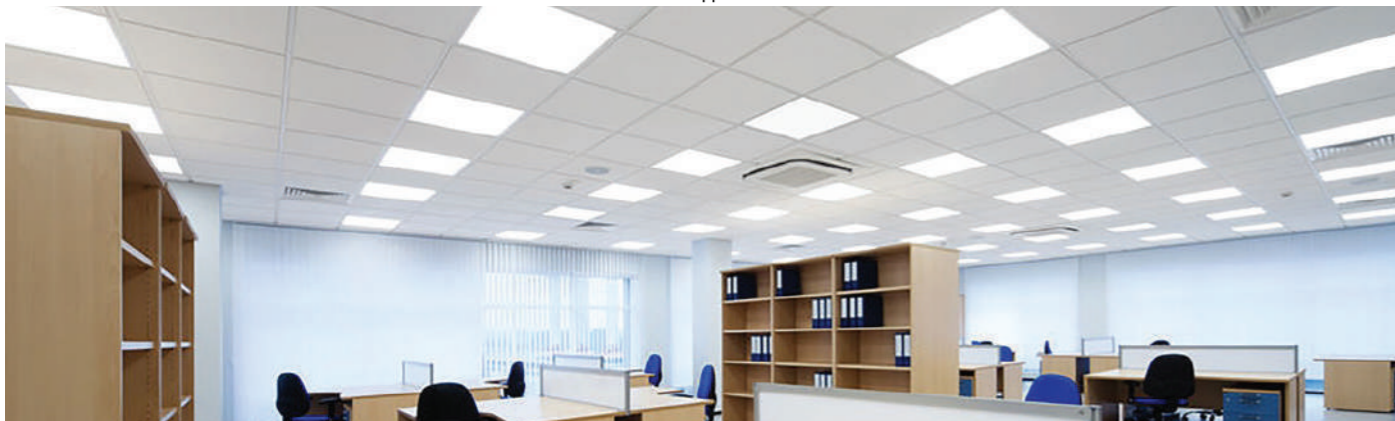

- * Easy maintenance
- Modular LED for easy replacement
- Opening and closing possible of LED module part and power supply part
- Customizable beam angle
- Temperature max 50°



ZERON
NEW LIGHT NEW LIFE

Line Grill Lamp
ZERN-DT01

>90
CRI

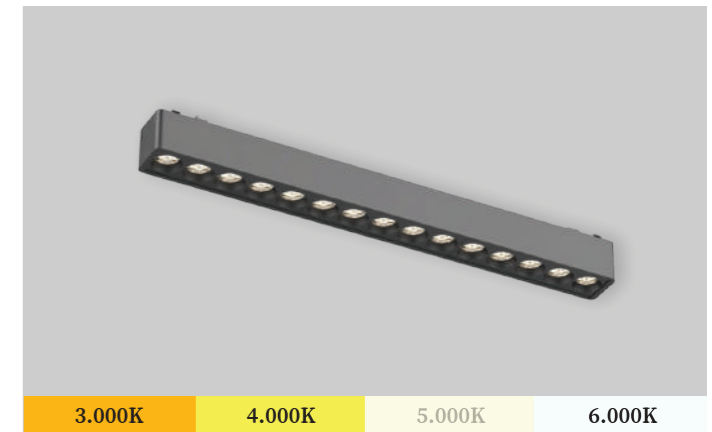

Specification

Daya (W)	Input Voltage	Frequency Amp	LED Efikasi	Total Lumen	CRI	Temperatur Warna	Proteksi	Beam Angle	Material
5W 10W 15W 20W 25W	DC 48V	50/60Hz	80Lm/W	400Lm 800Lm 1.200Lm 1.600Lm 2.000Lm	>80Ra Optional (>90Ra, >95Ra)	3000K/4000K/5000K	IP20	24°/36°	Aluminium

Model : ZERN-DT01-6T-5W

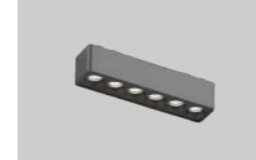

Dimension (mm)

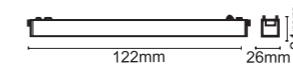

Model : ZERN-DT01-24T-20W



Dimension (mm)

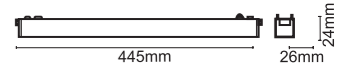

Model : ZERN-DT01-12T-10W



Dimension (mm)

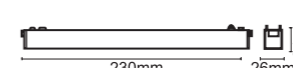

Model : ZERN-DT01-30T-25W



Dimension (mm)

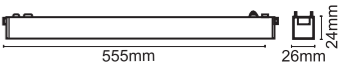

Model : ZERN-DT01-18T-15W



Dimension (mm)

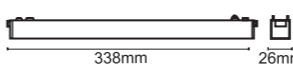

Application



- * Easy maintenance
- Modular LED for easy replacement
- Opening and closing possible of LED module part and power supply part
- Customizable beam angle
- Temperature max 50°



ZERON
NEW LIGHT NEW LIFE

Line Grill Lamp

ZERN-DT02

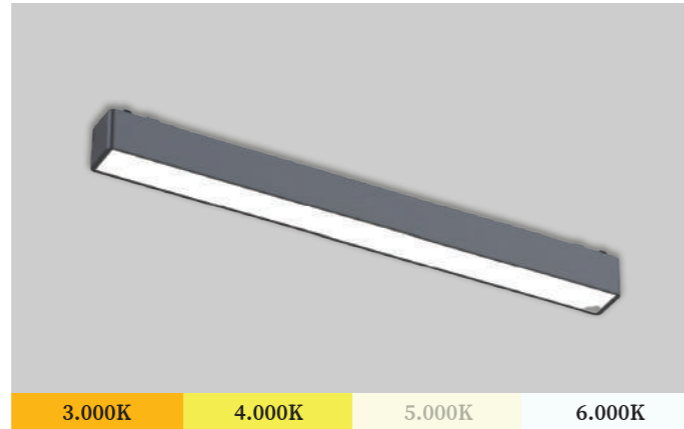

■ Specification

Daya (W)	Input Voltage	Frequency Amp	LED Efikasi	Total Lumen	CRI	Temperatur Warna	Proteksi	Beam Angle	Material
5W 10W 15W 20W 30W	DC 48V	50/60Hz	80Lm/W	400Lm 800Lm 1.200Lm 1.600Lm 2.400Lm	>80Ra Optional (>90Ra, >95Ra)	3000K/4000K/5000K	IP20	150°	Aluminium

Model : ZERN-DT02-6F-5W



Dimension (mm)

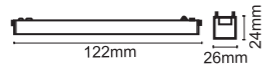

Model : ZERN-DT02-600F-20W

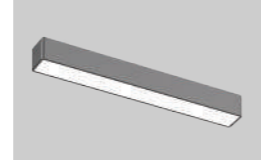

Dimension (mm)

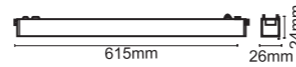

Model : ZERN-DT02-12F-10W

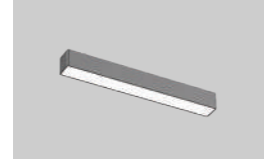

Dimension (mm)



Model : ZERN-DT02-900F-30W

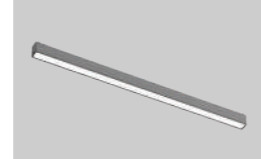

Dimension (mm)

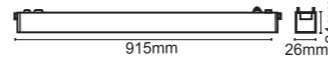

Model : ZERN-DT02-300F-15W

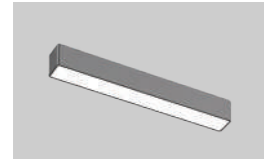

Dimension (mm)



Application

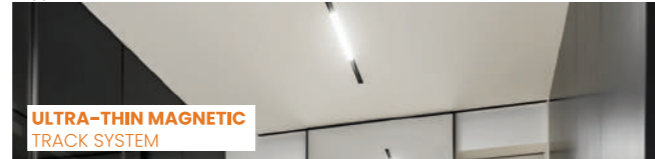

* Easy maintenance
- Modular LED for easy replacement
- Opening and closing possible of LED module part and power supply part
- Customizable beam angle
- Temperature max 50°



ECO
LUXON

Raceway Ecoluxon

ELX-LILT

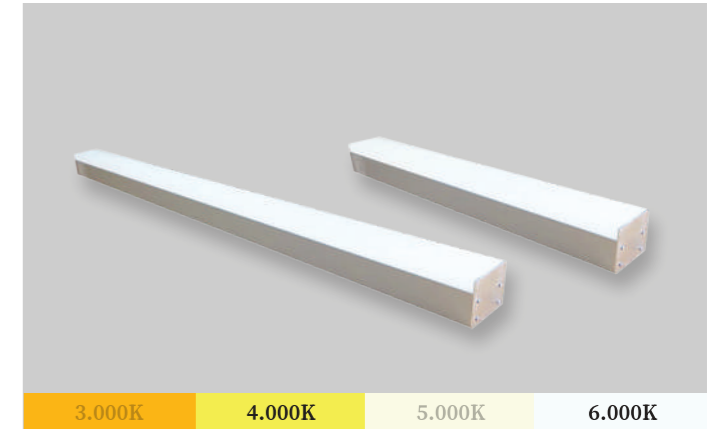

■ Specification

Daya (W)	Input Voltage	Frequency Amp	LED Efikasi	Total Lumen	CRI	Temperatur Warna	Dimensi	Berat	Material
18W	AC170-265V	50/60Hz	140Lm/W	2.520Lm	>80Ra	5000K	590x75x55mm	1kg	Die Casting Aluminium + PS
36W	AC170-265V	50/60Hz	140Lm/W	5.040Lm	>80Ra	5000K	1.180x75x55mm	2kg	Die Casting Aluminium + PS

Model : ELX-LILT60-18W



Dimension (mm)

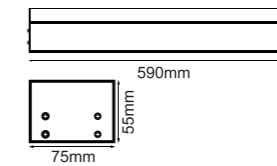

Light Distribution Curve

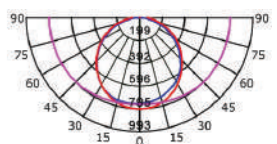

Model : ELX-LILT120-36W

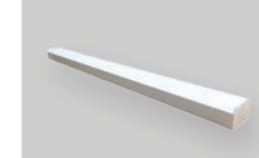

Dimension (mm)

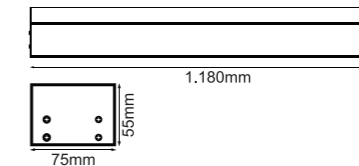

Light Distribution Curve

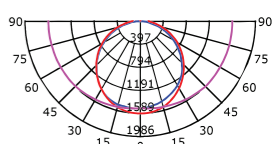

Accessories

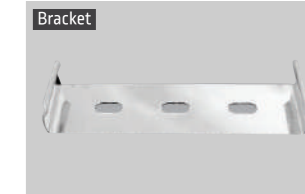
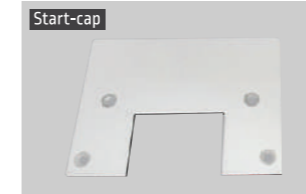

* Easy maintenance
- Modular LED for easy replacement
- Opening and closing possible of LED module part and power supply part
- Customizable beam angle
- Temperature max 50°



ECO
LUXON
Dustproof Ecoluxon
ELX-LIDT

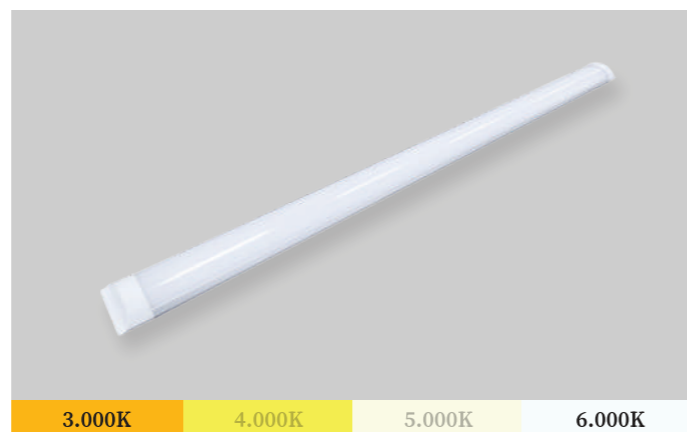

■ **Specification**

Daya (W)	Input Voltage	Frequency Amp	LED Efikasi	Total Lumen	CRI	Temperatur Warna	Proteksi	Berat	Material
20W	AC100-265V	50/60Hz	90Lm/W	1.800Lm	>80Ra	3000K/6000K	IP20	350gr	Aluminium + PC Cover
40W				3.600Lm				450gr	
50W				4.500Lm				550gr	

Model : ELX-LIDT-20W
: ELX-LIDT-40W



Dimension [mm]

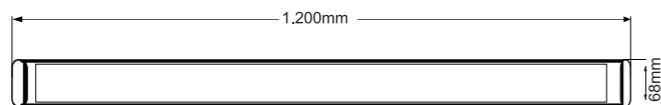

Model : ELX-LIDT-50W



Dimension [mm]

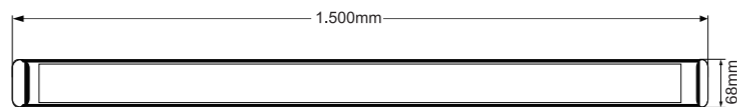

Light Distribution Curve

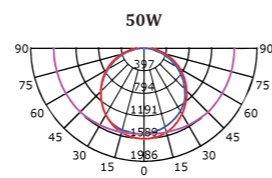
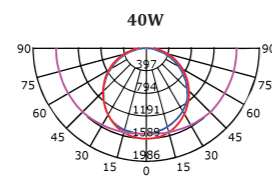
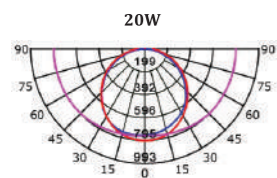

- * Easy maintenance
- Modular LED for easy replacement
- Opening and closing possible of LED module part and power supply part
- Customizable beam angle
- Temperature max 50°



ECO
LUXON
Twin-Head Emergency Light
ELX-EMLI180-3W



■ **Specification**

Daya (W)	Input Voltage	Frequency Amp	Battery Voltage	Battery Capacity	Emergency Time	Charging Time	Indicator	Temp. Warna	Material
2x3W	AC100-240V	50/60Hz	3.6V	300mAh	3 Hours	24 Hours	Charger, Power	6500K	Fire Retardant Plastic

ECO
LUXON
Art-Emergency Downlight
ELX-WM90-6W



■ **Specification**

Daya (W)	Input Voltage	Frequency Amp	Temp Warna	Battery Capacity	Emergency Time	Charging Time	Emergency Power	Dimension
6W	220V ±10%	50/60Hz	6500K	2400mAh/3.2V	180 Min	24 Hours	3W	ø120x85mm
Material								
Injection-molded thermoplastic ABS Housing UL-94V-0 flame rating, fire resistant								

- * Easy maintenance
- Modular LED for easy replacement
- Opening and closing possible of LED module part and power supply part
- Customizable beam angle
- Temperature max 50°





Exit Lamp Emergency

ELX-EXIT60LIT-3W



Specification

Daya (W)	Input Voltage	Frequency Amp	Battery Voltage	Battery Capacity	Emergency Time	Charging Time	Indicator	Temp. Warna	Material
3W	AC100-240V	50/60Hz	3.6V	300mAh	120 Min	24 Hours	Charger, Power	6500K	Fire Reterdant Plastic

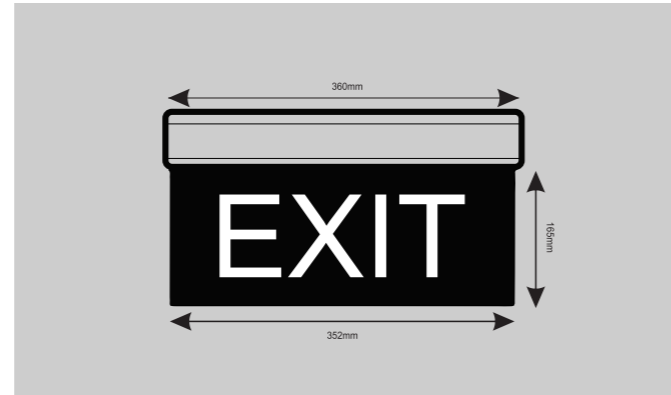

Hanging Wall Accessories

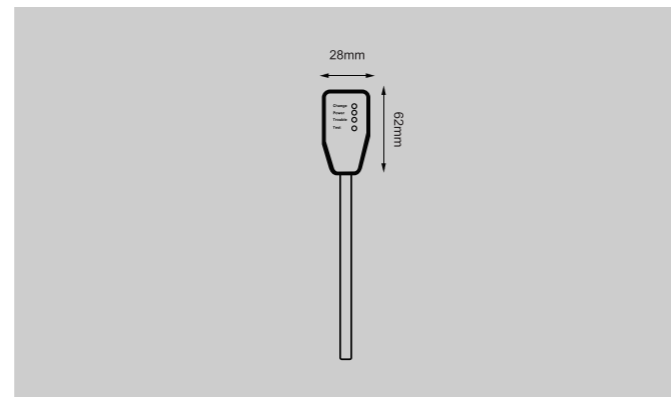

OUTDOOR LIGHTING

- * Easy maintenance
- Modular LED for easy replacement
- Opening and closing possible of LED module part and power supply part
- Customizable beam angle
- Temperature max 50°



ZERON
NEW LIGHT NEW LIFE

Street Light Zeron

ZERN-STH-ZRSM



■ Specification

Daya (W)	Input Voltage	Frequency Amp	LED Efikasi	Total Lumen	CRI	Temperatur Warna	Proteksi	Beam Angle	Berat	Material
30W	AC100-277V	50/60Hz	160Lm/W	4.800Lm	>70Ra	3000K/5000K	IP66	120°	2.8kg	Die Casting Aluminium + Polycarbonate
40W				6.400Lm					2.8kg	
50W				8.000Lm					2.8kg	
70W				11.200Lm					3.9kg	
90W				14.400Lm					3.9kg	
120W				19.200Lm					3.9kg	
150W				24.000Lm					4.9kg	

Model : ZERN-STH-ZRSM-30W
ZERN-STH-ZRSM-40W
ZERN-STH-ZRSM-50W



Dimension (mm)

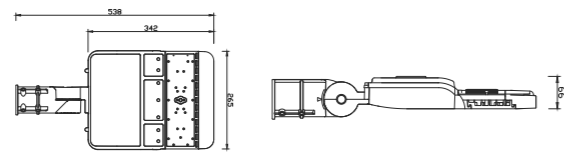

Light Distribution Curve

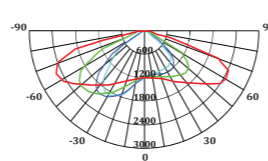

Model : ZERN-STH-ZRSM-70W
ZERN-STH-ZRSM-90W
ZERN-STH-ZRSM-120W

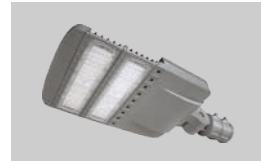

Dimension (mm)

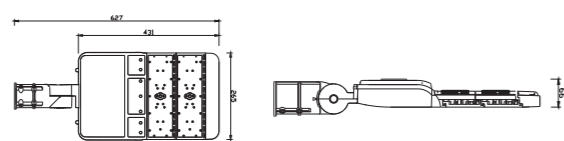

Light Distribution Curve

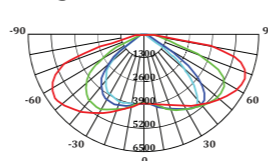

Model : ZERN-STH-ZRSM-150W



Dimension (mm)

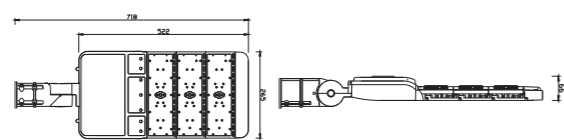

Light Distribution Curve

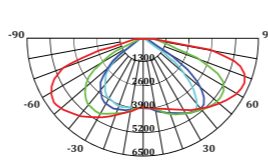

- * Easy maintenance
- Modular LED for easy replacement
- Opening and closing possible of LED module part and power supply part
- Customizable beam angle
- Temperature max 50°



ECO **LUXON**

Street Light Ecoluxon

ELX-CBR-ECCOB



■ Specification

Daya (W)	Input Voltage	Frequency Amp	LED Efikasi	Total Lumen	CRI	Temperatur Warna	Proteksi	Beam Angle	Berat	Material
30W	AC170-265V	50/60Hz	110Lm/W	3.300Lm	>70Ra	3000K/6000K	IP66	160°	1kg	Die Casting Aluminium
50W				5.500Lm					2kg	
100W				11.000Lm					3kg	
150W				16.500Lm					4kg	

Model : ELX-CBR-ECCOB-30W



Dimension (mm)

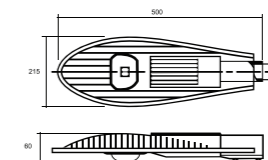

Light Distribution Curve

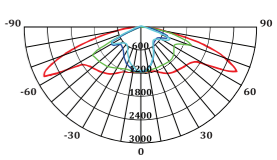

Model : ELX-CBR-ECCOB-50W



Dimension (mm)

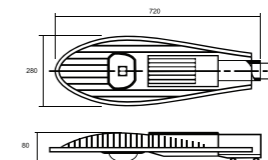

Light Distribution Curve

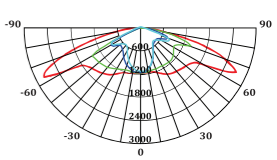

Model : ELX-CBR-ECCOB-100W



Dimension (mm)

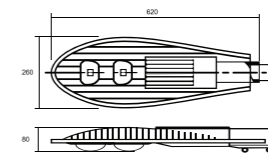

Light Distribution Curve

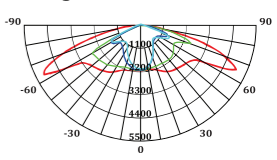

Model : ELX-CBR-ECCOB-150W



Dimension (mm)

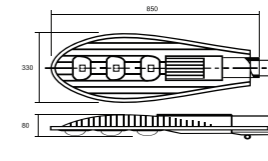

Light Distribution Curve

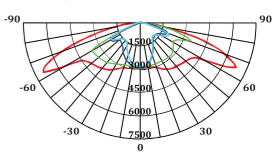

- * Easy maintenance
- Modular LED for easy replacement
- Opening and closing possible of LED module part and power supply part
- Customizable beam angle
- Temperature max 50°



ECO **LUXON**
Street Light Ecoluxon
ELX-SSD-ECSM



3.000K 4.000K 5.000K 6.000K

■ **Specification**

Daya (W)	Input Voltage	Frequency Amp	LED Efikasi	Total Lumen	CRI	Temperatur Warna	Proteksi	Beam Angle	Berat	Material
10W	AC170-240V	50/60Hz	120Lm/W	1.200Lm	>70Ra	3000K/6000K	IP66	120°	600gr	Die Casting Aluminium
20W				2.400Lm					600gr	
50W				6.000Lm					1kg	
70W				8.400Lm					1.7kg	
100W				12.000Lm					1.7kg	
150W				18.000Lm					2.5kg	

Model : ELX-SSD-ECSM-10W/20W



Dimension (mm)

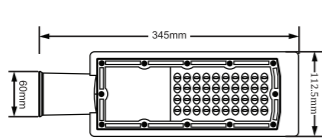

Light Distribution Curve

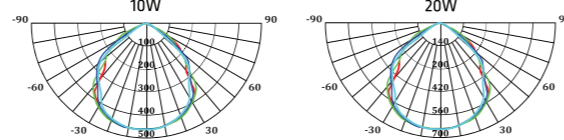

Model : ELX-SSD-ECSM-50W



Dimension (mm)

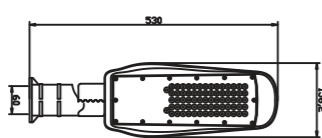

Light Distribution Curve

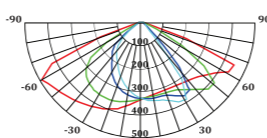

Model : ELX-SSD-ECSM-70W
ELX-SSD-ECSM-100W



Dimension (mm)

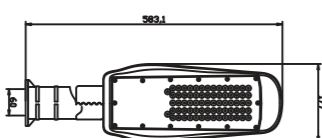

Light Distribution Curve

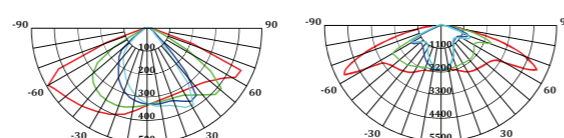

Model : ELX-SSD-ECSM-150W



Dimension (mm)

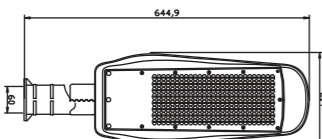

Light Distribution Curve

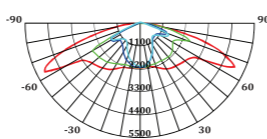

- * Easy maintenance
- Modular LED for easy replacement
- Opening and closing possible of LED module part and power supply part
- Customizable beam angle
- Temperature max 50°



ZERON
NEW LIGHT NEW LIFE

All In One Solar Light
ELE-20



3.000K 4.000K 5.000K 6.000K

■ **Specification**

Daya (W)	Frequency Amp	LED Efikasi	Total Lumen	CRI	Proteksi	Life Po4 Battery	Charging Time	Material
20W	50/60Hz	160Lm/W	3.200Lm	>80Ra	IP65	12.8V, 48Ah	12 Jam	Die Casting Aluminium
30W			4.800Lm			12.8V, 72Ah		
40W			6.400Lm			12.8V, 96Ah		
50W			8.000Lm			12.8V, 120Ah		
60W			9.600Lm			12.8V, 144Ah		

Model : ELE-20-20W



Dimension (mm)

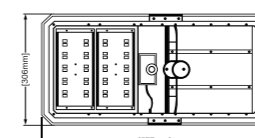

Light Distribution Curve

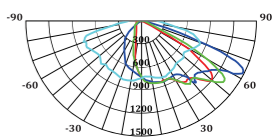

Model : ELE-20-30W



Dimension (mm)

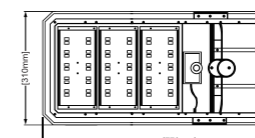

Light Distribution Curve

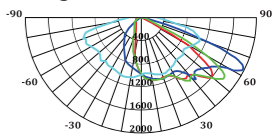

Model : ELE-20-40W



Dimension (mm)

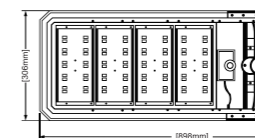

Light Distribution Curve

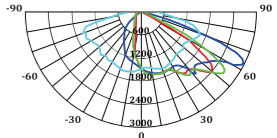

Model : ELE-20-50W



Dimension (mm)

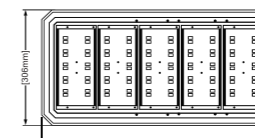

Light Distribution Curve

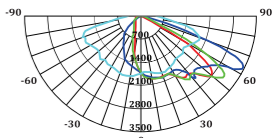

Model : ELE-20-60W



Dimension (mm)

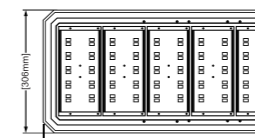

Light Distribution Curve

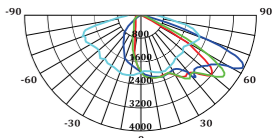

- * Easy maintenance
- Modular LED for easy replacement
- Opening and closing possible of LED module part and power supply part
- Customizable beam angle
- Temperature max 50°



ZERON
NEW LIGHT NEW LIFE

All In One Solar Light

ELE-20



3.000K 4.000K 5.000K 6.000K

■ Specification

Daya (W)	Frequency Amp	LED Efikasi	Total Lumen	CRI	Proteksi	Life Po4 Battery	Charging Time	Material
80W	50/60Hz	160Lm/W	12.800Lm	>80Ra	IP65	12.8V, 192Ah	12 Jam	Die Casting Aluminium
100W			16.000Lm			12.8V, 240Ah		
120W			19.200Lm			12.8V, 260Ah		
150W			24.000Lm			12.8V, 288Ah		

Model : ELE-20-80W/100W



Dimension (mm)

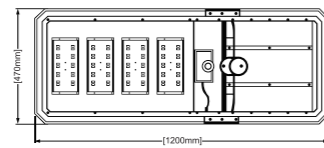

Light Distribution Curve

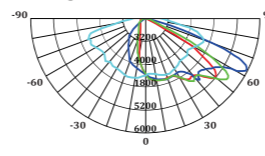

Model : ELX-ECDL-MPF-120W



Dimension (mm)

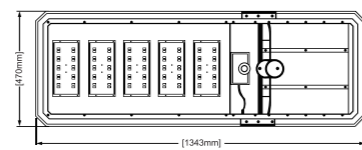

Light Distribution Curve

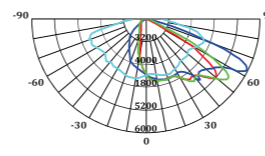

Model : ELX-ECDL-MPF-150W



Dimension (mm)

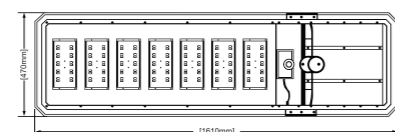

Light Distribution Curve

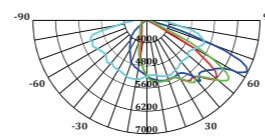

- * Easy maintenance
- Modular LED for easy replacement
- Opening and closing possible of LED module part and power supply part
- Customizable beam angle
- Temperature max 50°



ZERON
NEW LIGHT NEW LIFE

Flood Light Zeron

ZERN-FLH-ZRSM



3.000K 4.000K 5.000K 6.000K

■ Specification

Daya (W)	Input Voltage	Frequency Amp	LED Efikasi	Total Lumen	CRI	Temperatur Warna	Proteksi	Beam Angle	Berat	Material
50W	AC170-277V	50/60Hz	150Lm/W	7500Lm	>70Ra	3000K/5000K	IP66	30°/60°/90°	2kg	Die Casting Aluminium
100W			15.000Lm	3.3kg						
150W			22.500Lm	4.4kg						
200W			30.000Lm	5.2kg						

Model : ZERN-FLH-ZRSM-50W



Dimension (mm)

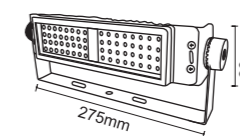

Light Distribution Curve

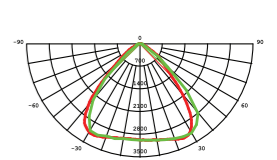

Model : ZERN-FLH-ZRSM-100W



Dimension (mm)

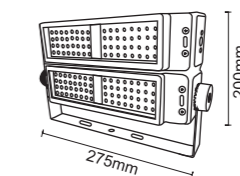

Light Distribution Curve

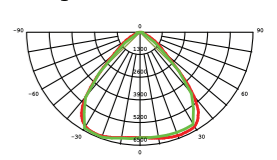

Model : ZERN-FLH-ZRSM-150W



Dimension (mm)

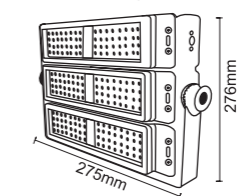

Light Distribution Curve

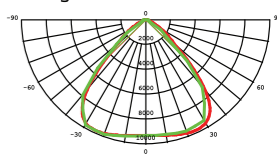

Model : ZERN-FLH-ZRSM-200W



Dimension (mm)

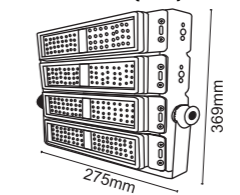

Light Distribution Curve

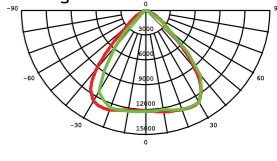

- * Easy maintenance
- Modular LED for easy replacement
- Opening and closing possible of LED module part and power supply part
- Customizable beam angle
- Temperature max 50°



ZERON
NEW LIGHT NEW LIFE

Flood Light Zeron

ZERN-FL-ZRSM



ZERON
NEW LIGHT NEW LIFE

Flood Light Zeron

ZERN-FL-ZRSM



■ Specification

Daya (W)	Input Voltage	Frequency Amp	LED Efikasi	Total Lumen	CRI	Temperatur Warna	Proteksi	Beam Angle	Berat	Material
300W	AC170-277V	50/60Hz	150Lm/W	45.000Lm	>70Ra	3000K/5000K	IP66	20°/30°/60°/90°	9.4kg	Die Casting Aluminium
400W	AC170-277V	50/60Hz	150Lm/W	75.000Lm	>70Ra	3000K/5000K	IP66	20°/30°/60°/90°	10kg	Die Casting Aluminium

Daya (W)	Input Voltage	Frequency Amp	LED Efikasi	Total Lumen	CRI	Temperatur Warna	Proteksi	Beam Angle	Berat	Material
500W	AC170-277V	50/60Hz	150Lm/W	75.000Lm	>70Ra	3000K/5000K	IP66	20°/30°/60°/90°	12.8kg	Die Casting Aluminium
750W				112.500Lm					17.2kg	
1000W				150.000Lm					22kg	

Model : ZERN-FL-ZRSM-300W



Dimension [mm]

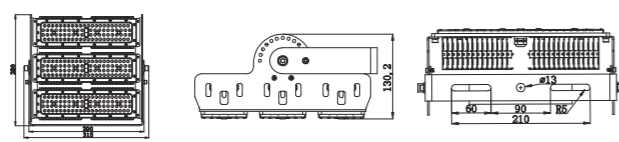

Light Distribution Curve

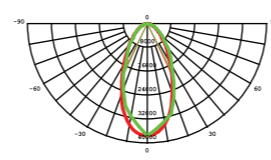

Model : ZERN-FL-ZRSM-500W



Dimension [mm]

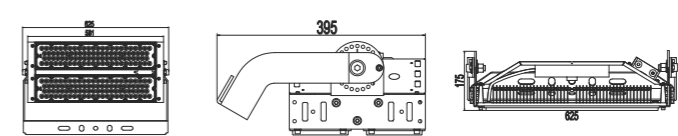

Light Distribution Curve

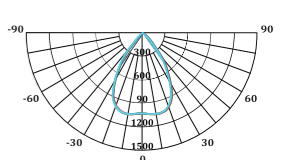

Model : ZERN-FL-ZRSM-750W



Dimension [mm]

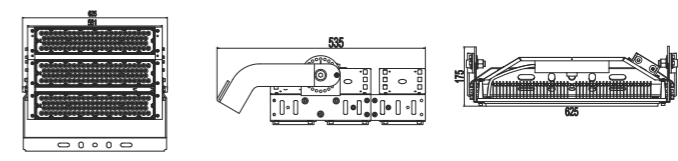

Light Distribution Curve

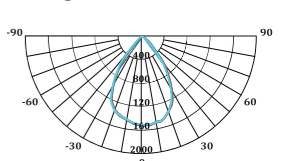

Model : ZERN-FL-ZRSM-400W



Dimension [mm]

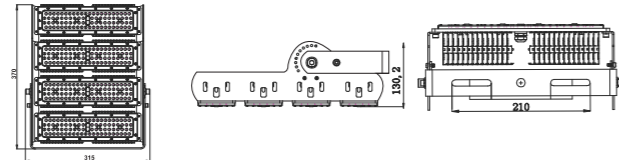

Light Distribution Curve

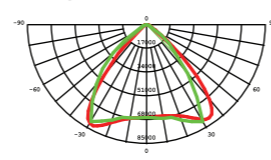

Model : ZERN-FL-ZRSM-1000W



Dimension [mm]

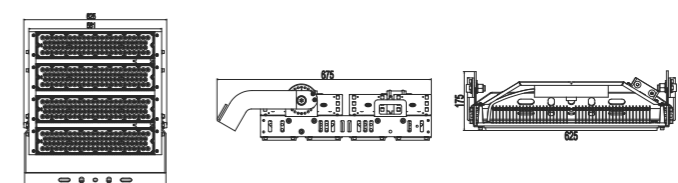

Light Distribution Curve

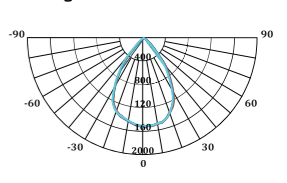

* Easy maintenance
- Modular LED for easy replacement
- Opening and closing possible of LED module part and power supply part
- Customizable beam angle
- Temperature max 50°

* Easy maintenance
- Modular LED for easy replacement
- Opening and closing possible of LED module part and power supply part
- Customizable beam angle
- Temperature max 50°

ZERON
NEW LIGHT NEW LIFE

Flood Light Zeron

ZERN-FL-ZRSM



3.000K 4.000K 5.000K 6.000K

■ Specification

Daya (W)	Input Voltage	Frequency Amp	LED Efikasi	Total Lumen	CRI	Temperatur Warna	Proteksi	Beam Angle	Berat	Material
1250W	AC170-277V	50/60Hz	150Lm/W	187500Lm	>70Ra	3000K/5000K	IP66	20°/30°/60°/90°	9.4kg	Die Casting Aluminium
1500W	AC170-277V	50/60Hz	150Lm/W	225.000Lm	>70Ra	3000K/5000K	IP66	20°/30°/60°/90°	10kg	Die Casting Aluminium

Model : ZERN-FL-ZRSM-1250W



Dimension (mm)

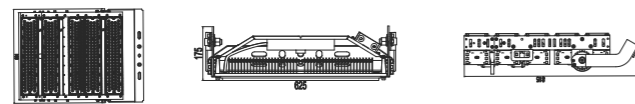

Light Distribution Curve

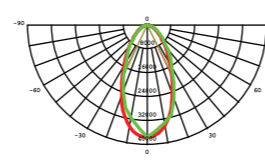

Model : ZERN-FL-ZRSM-1500W



Dimension (mm)

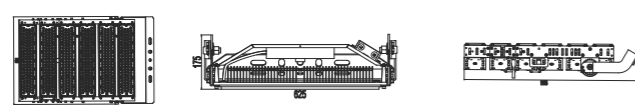

Light Distribution Curve

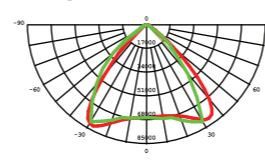

Light Distribution Curve

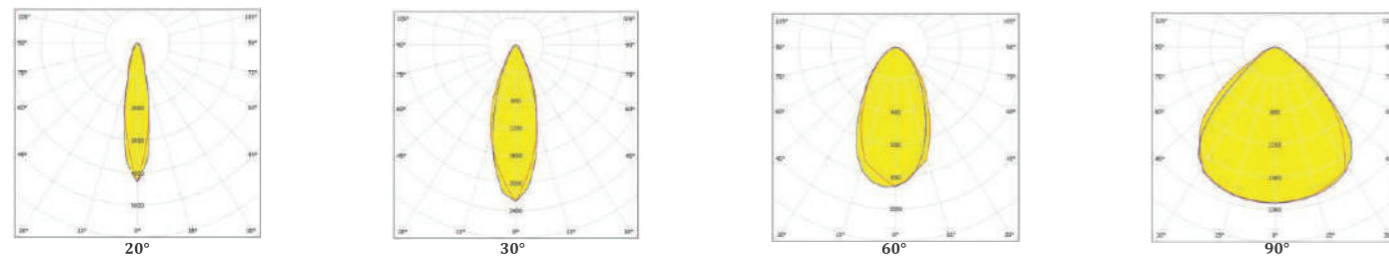

- * Easy maintenance
- Modular LED for easy replacement
- Opening and closing possible of LED module part and power supply part
- Customizable beam angle
- Temperature max 50°



ECO **LUXON**

Flood Light Ecoluxon

ELX-ECOSM

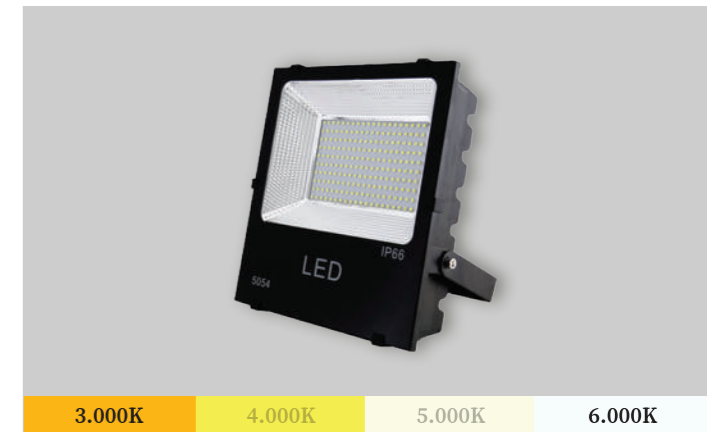

3.000K 4.000K 5.000K 6.000K

■ Specification

Daya (W)	Input Voltage	Frequency Amp	LED Efikasi	Total Lumen	CRI	Temperatur Warna	Proteksi	Beam Angle	Berat	Material
10W	AC170-240V	50/60Hz	100Lm/W	1.000Lm	>70Ra	3000K/6000K	IP66	90°	0.3kg	Die Casting Aluminium
30W			3.000Lm	0.6kg						
50W			5.000Lm	1.05kg						
100W			10.000Lm	1.34kg						

Model : ELX-FL-ECOSM-10W



Dimension (mm)

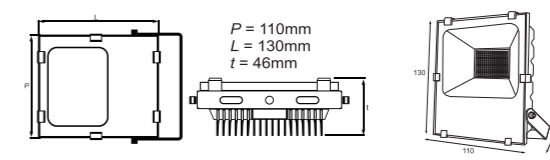

Light Distribution Curve

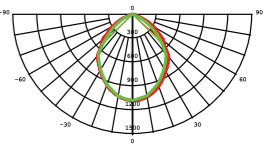

Model : ELX-FL-ECOSM-30W



Dimension (mm)

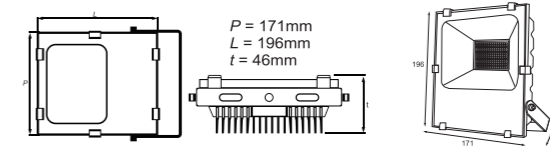

Light Distribution Curve

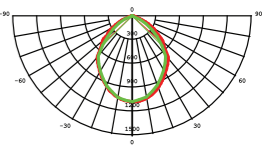

Model : ELX-FL-ECOSM-50W



Dimension (mm)

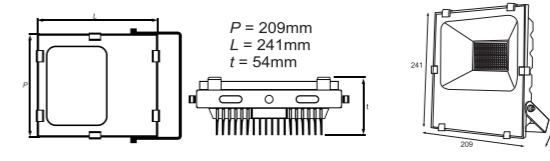

Light Distribution Curve

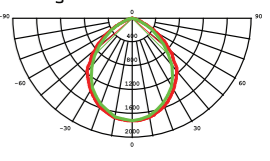

Model : ELX-FL-ECOSM-100W



Dimension (mm)

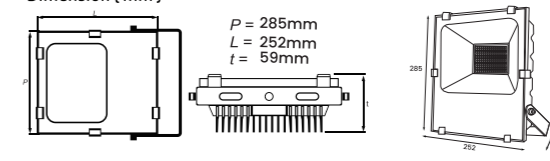

Light Distribution Curve

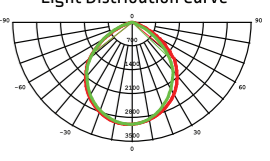

- * Easy maintenance
- Modular LED for easy replacement
- Opening and closing possible of LED module part and power supply part
- Customizable beam angle
- Temperature max 50°



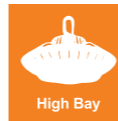

ECO LUXON

High Bay Ecoluxon

ELX-HB



ECO LUXON

High Bay Ecoluxon

ELX-HB



Specification

Daya (W)	Input Voltage	Frequency Amp	LED Efikasi	Total Lumen	CRI	Temperatur Warna	Proteksi	Beam Angle	Berat	Working Temp	Material
30W	AC170-277V	50/60Hz	150Lm/W	4.500Lm	>70Ra	6000K	IP65	60°/90°/120°	1.8kg	-20-45°C	Graphene
50W				7.500Lm					1.8kg		
80W				12.000Lm					2.1kg		
100W				15.000Lm					2.1kg		

Specification

Daya (W)	Input Voltage	Frequency Amp	LED Efikasi	Total Lumen	CRI	Temperatur Warna	Proteksi	Beam Angle	Berat	Working Temp	Material
120W	AC170-277V	50/60Hz	150Lm/W	18.000Lm	>70Ra	6000K	IP65	60°/90°/120°	3kg	-20-45°C	Graphene
150W				22.500Lm					3kg		
200W				30.000Lm					3.9kg		

Model : ELX-HB-30W/50W



Dimension (mm)

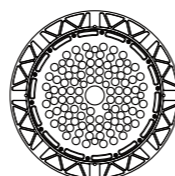
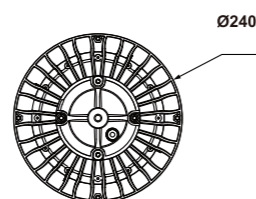
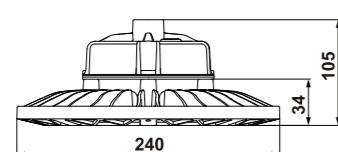

Model : ELX-HB-120W/150W



Dimension (mm)

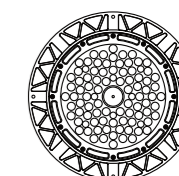
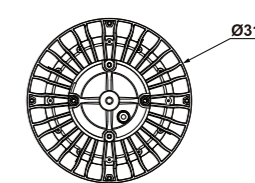
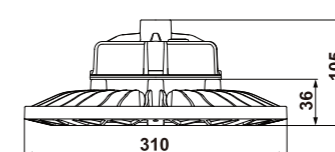

Model : ELX-HB-80W/100W



Dimension (mm)

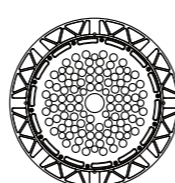
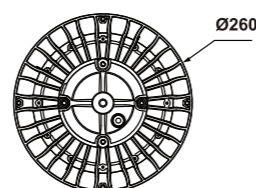
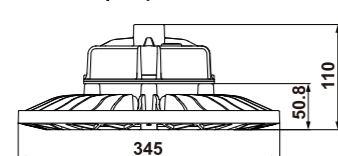

Model : ELX-HB-200W



Dimension (mm)

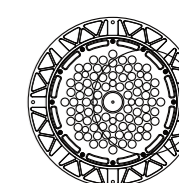
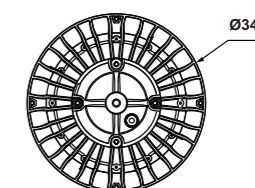
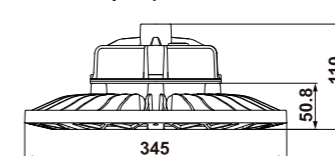

Dimension (mm)



M10 Hanging Hook



Mounting Bracket



Stainless Steel Safety Wire

Light Distribution Curve

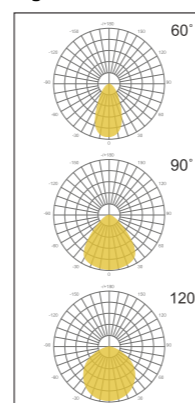

Iron Chain



Aluminium Lampshade



PC Lampshade

Dimension (mm)



M10 Hanging Hook



Mounting Bracket



Stainless Steel Safety Wire

Light Distribution Curve

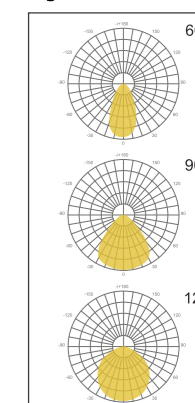

Iron Chain



Aluminium Lampshade



PC Lampshade

- * Easy maintenance
- Modular LED for easy replacement
- Opening and closing possible of LED module part and power supply part
- Customizable beam angle
- Temperature max 50°



- * Easy maintenance
- Modular LED for easy replacement
- Opening and closing possible of LED module part and power supply part
- Customizable beam angle
- Temperature max 50°





HIGH BAY LIGHT

Outdoor Light | High Bay 65



High Bay Ecoluxon

ELX-HBLT



Specification

Daya (W)	Input Voltage	Frequency Amp	LED Efikasi	Total Lumen	CRI	Temperatur Warna	Proteksi	Beam Angle	Berat	Material
150W	AC170-240V	50/60Hz	150Lm/W	22.500Lm	>80Ra	5000K, LM 80	IP65	90°	5kg	Aluminium Alloy

Model : ELX-HBLT-150W



Dimension (mm)

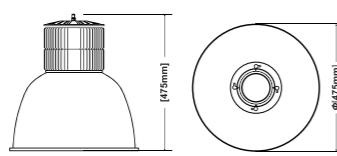

Light Distribution Curve

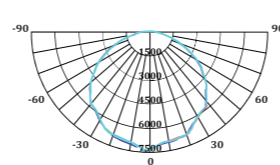

Application



- * Easy maintenance
- Modular LED for easy replacement
- Opening and closing possible of LED module part and power supply part
- Customizable beam angle
- Temperature max 50°



OBSTRUCTION LIGHT

Outdoor Light | Obstruction 66



LED Obstruction

ZERN-OBS-4W



Specification

Daya (W)	Input Voltage	Frequency Amp	Temperatur Warna	Proteksi	Beam Angle	Lifetime	Berat	Material
4W	AC 100-240V	50/60Hz	White, Red	IP65	120°	50.000 Hours	75Kg	Aviation yellow powder-coated die-casting Aluminum

Model : ZERN-OBS-4W



Dimension (mm)

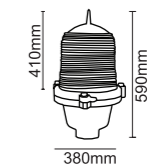

Application



- * Easy maintenance
- Modular LED for easy replacement
- Opening and closing possible of LED module part and power supply part
- Customizable beam angle
- Temperature max 50°





EXPLOSION PROOF

ZERON NEW LIGHT NEW LIFE

Explosion Proof Zeron OHBF8230-SS



■ Specification

Executive Standart	Rated Power	Rated Voltage	Weight	Size	Color Rendering	Power Factor	Beam Angle	Protection Level
GB3836.1 GB3836.2	10W 25W	AC220-240V 50/60Hz	1.4kg	ø145X130MM	≥75Ra	>0.95	120°	IP66
Anticorrosion Grade		Light Effect		Introduction Device		Explosion Proof Mark		
WF2		120Lm/W		G2/4" ø88MM-ø14MM		Ex d IIC T6 Gb/Ex TD A21 T80°C		

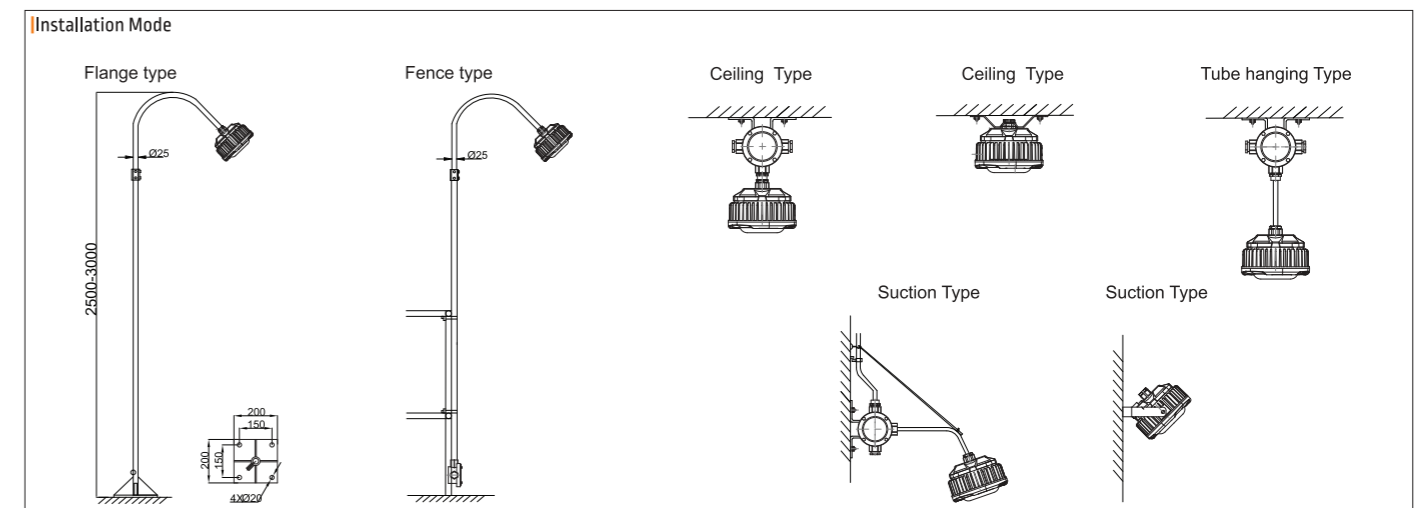
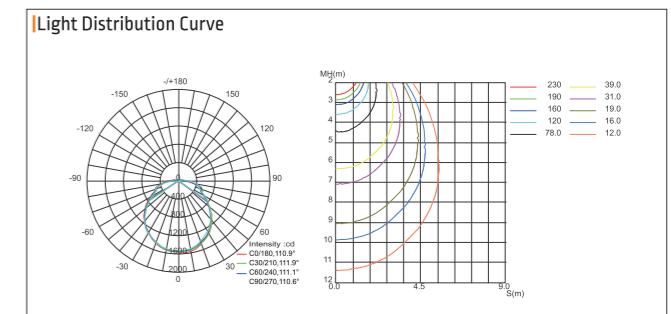
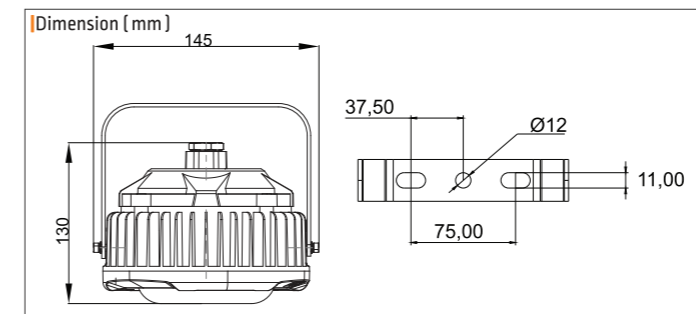

ZERON
NEW LIGHT NEW LIFE

Explosion Proof Zeron OHBF8230-BS



Specification

Executive Standart	Rated Power	Rated Voltage	Weight	Size	Color Rendering	Power Factor	Beam Angle	Protection Level
GB3836.1 GB3836.2	30W 50W	AC220-240V 50/60Hz	3.3kg	ø180X175MM	≥75Ra	>0.95	120°	IP66
Anticorrosion Grade		Light Effect		Introduction Device		Explosion Proof Mark		
WF2		120Lm/W		G2/4" ø88MM-ø14MM		Ex d IIC T6 Gb/Ex TD A21 T80°C		

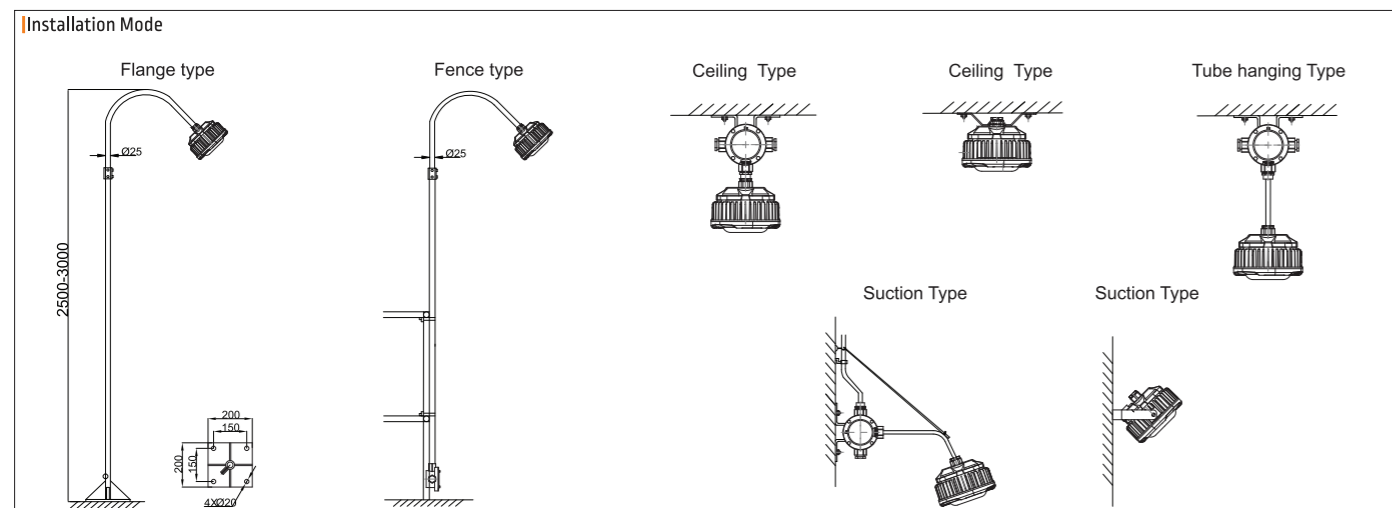
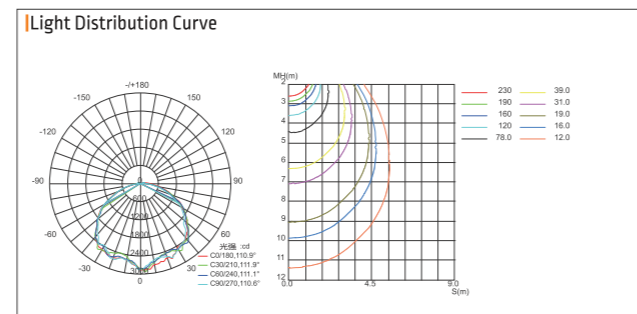
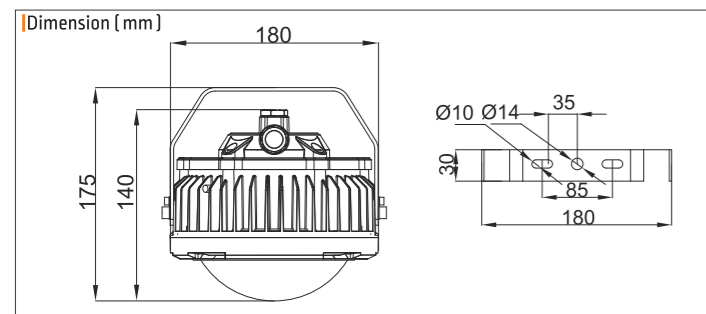

ZERON
NEW LIGHT NEW LIFE

Explosion Proof Zeron OHBF8231



Specification

Executive Standart	Rated Power	Rated Voltage	Weight	Size	Color Rendering	Power Factor	Beam Angle	Protection Level
GB3836.1 GB3836.2	50W 60W 80W 90W	AC170-270V 50/60Hz	5.5kg	ø252X201MM	≥75Ra	>0.95	122.4°	IP66
Anticorrosion Grade		Light Effect		Introduction Device		Explosion Proof Mark		
WF2		120Lm/W		G3/4" ø88MM-ø14MM		Ex d IIC T6 Gb/Ex TD A21 T80°C		

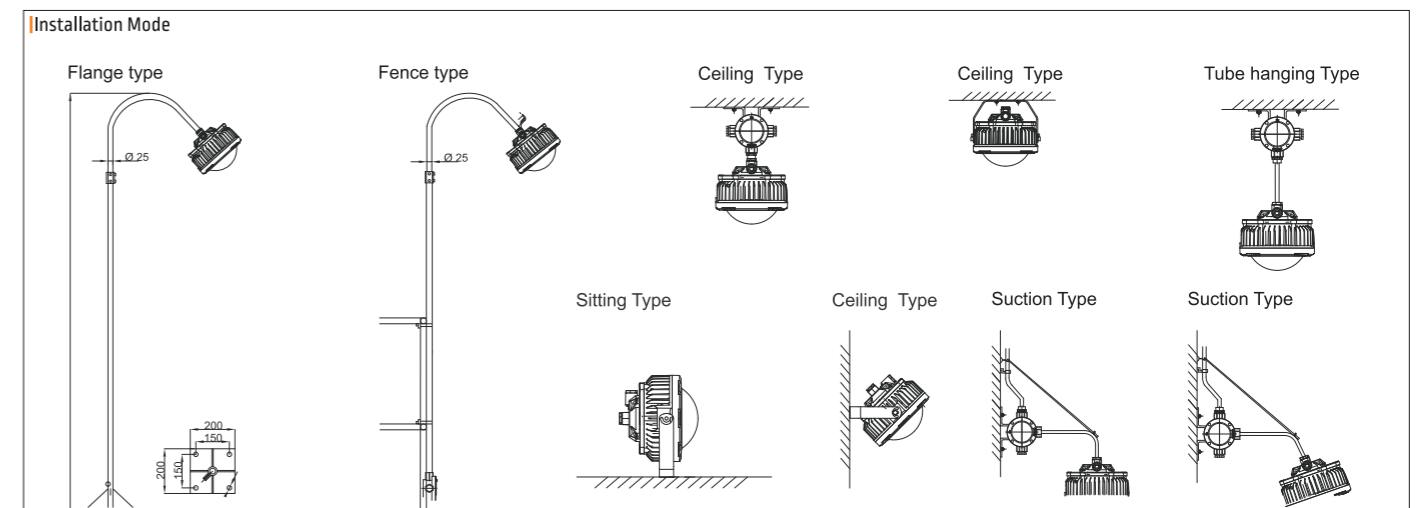
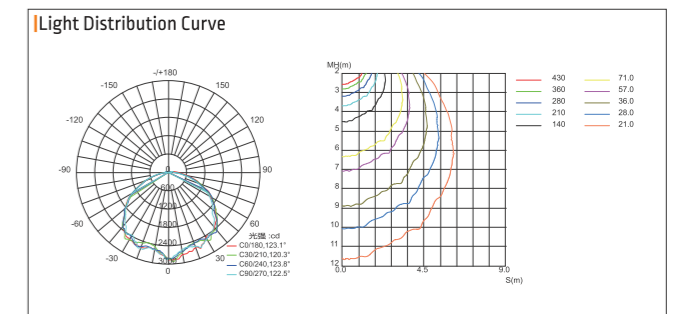
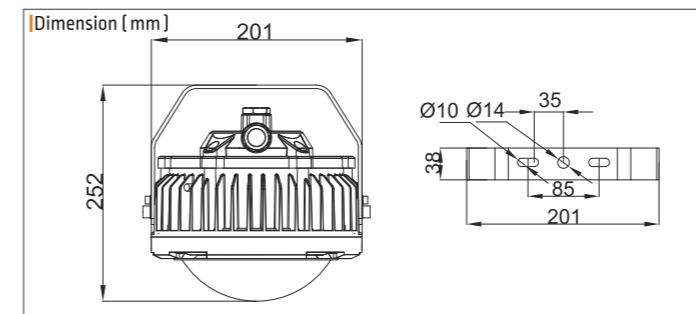

ZERON
NEW LIGHT NEW LIFE

Explosion Proof Zeron

OHBF8236

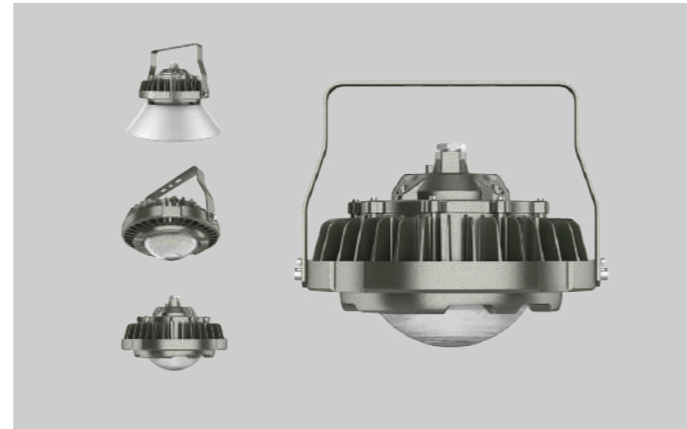

Specification

Executive Standart	Rated Power	Rated Voltage	Weight	Size	Color Rendering	Power Factor	Beam Angle	Protection Level
GB3836.1 GB3836.2	100W 120W 150W	AC100-270V 50/60Hz	10.8kg	ø378X242MM	≥75Ra	>0.95	94.1°	IP66
Anticorrosion Grade		Light Effect		Introduction Device		Explosion Proof Mark		
WF2		120Lm/W		G3/4"ø8MM-ø14MM		Ex d IIC T6 Gb/Ex TD A21 T80°C		

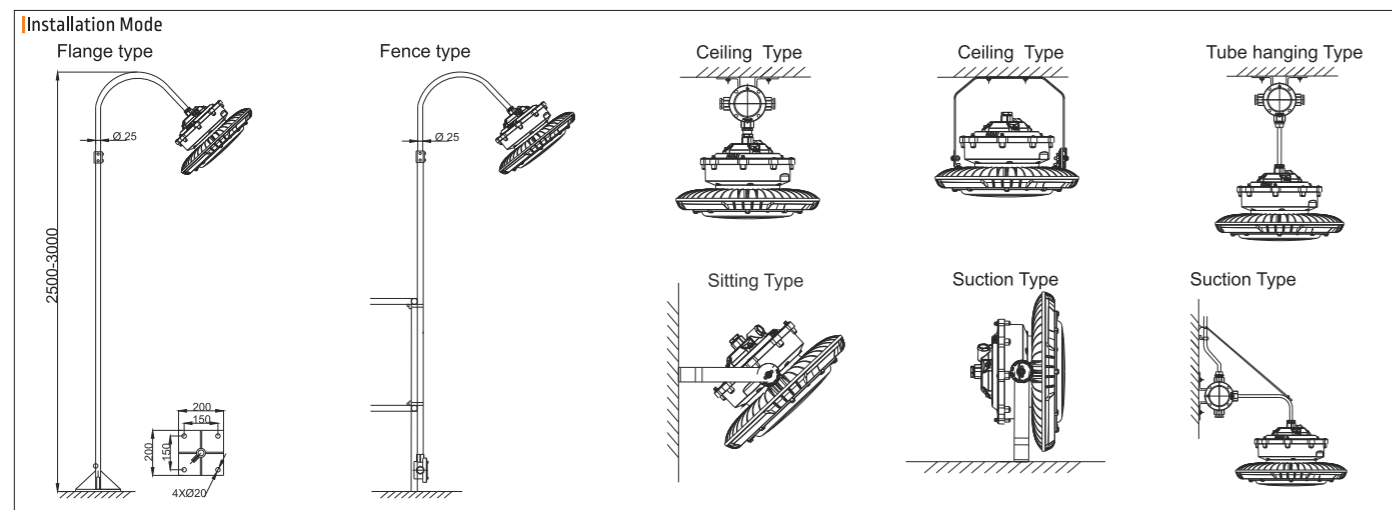
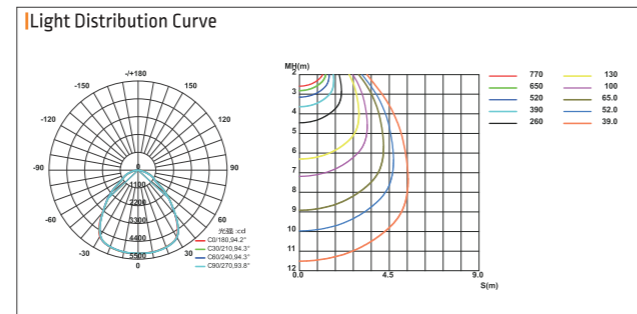
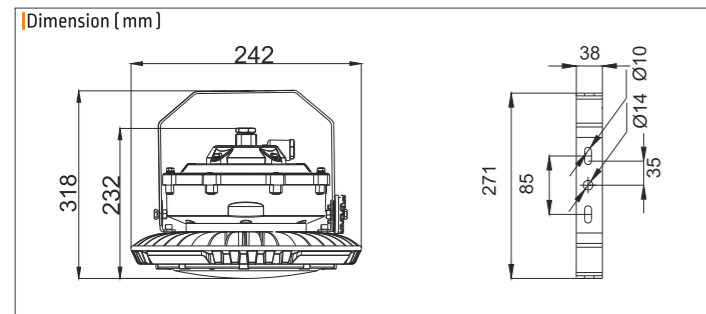

ZERON
NEW LIGHT NEW LIFE

Explosion Proof Zeron

OHBF8235



Specification

Executive Standart	Rated Power	Rated Voltage	Weight	Size	Color Rendering	Power Factor	Beam Angle	Protection Level
GB3836.1 GB3836.2	150W 200W 240W	AC170-270V 50/60Hz	8.8kg	ø415X351MM	≥75Ra	>0.95	94.1°	IP66
Anticorrosion Grade		Light Effect		Introduction Device		Explosion Proof Mark		
WF2		120Lm/W		G3/4"ø8MM-ø14MM		Ex d IIC T6 Gb/Ex TD A21 T80°C		

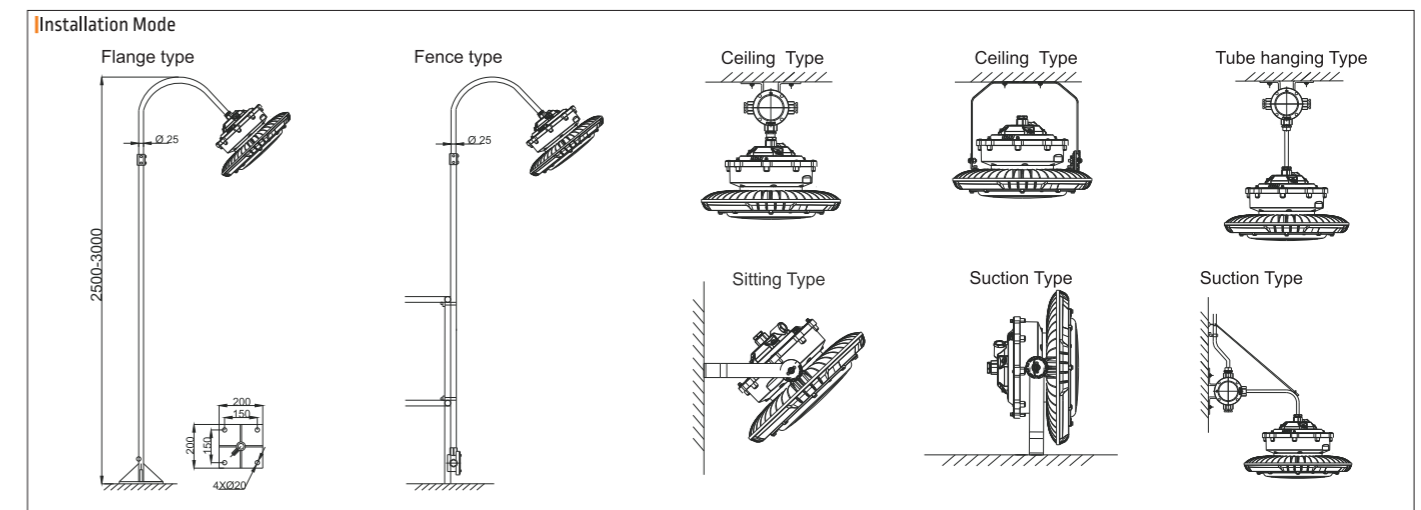
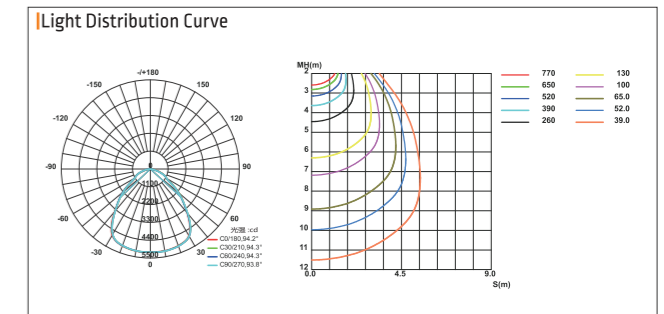
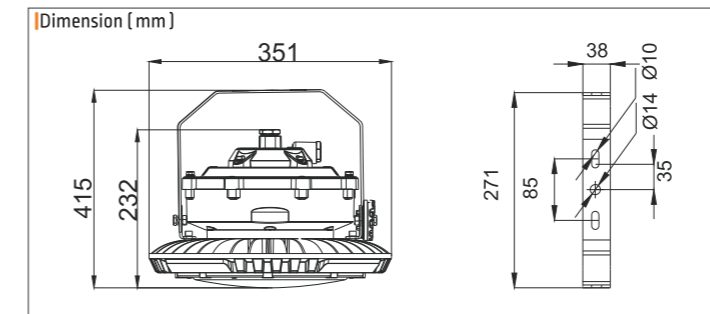

ZERON
NEW LIGHT NEW LIFE

Explosion Proof Zeron OHBF8260-SS

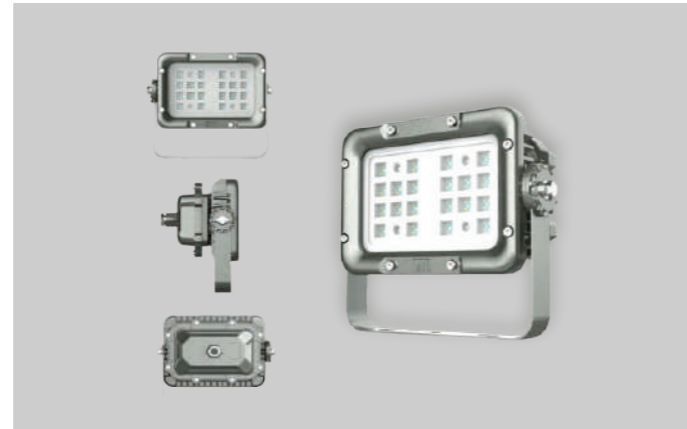

Specification

Executive Standart	Rated Power	Rated Voltage	Weight	Size	Color Rendering	Power Factor	Beam Angle	Protection Level
GB3836.1 GB3836.2	75W 100W 120W	AC100-270V 50/60Hz	6.7kg	ø299X186X174MM	≥75Ra	>0.95	106.5°	IP66
Anticorrosion Grade		Light Effect		Introduction Device		Explosion Proof Mark		
WF2		120Lm/W		G3/4"ø8MM-ø14MM		Ex d IIC T6 Gb/Ex TD A21 T80°C		

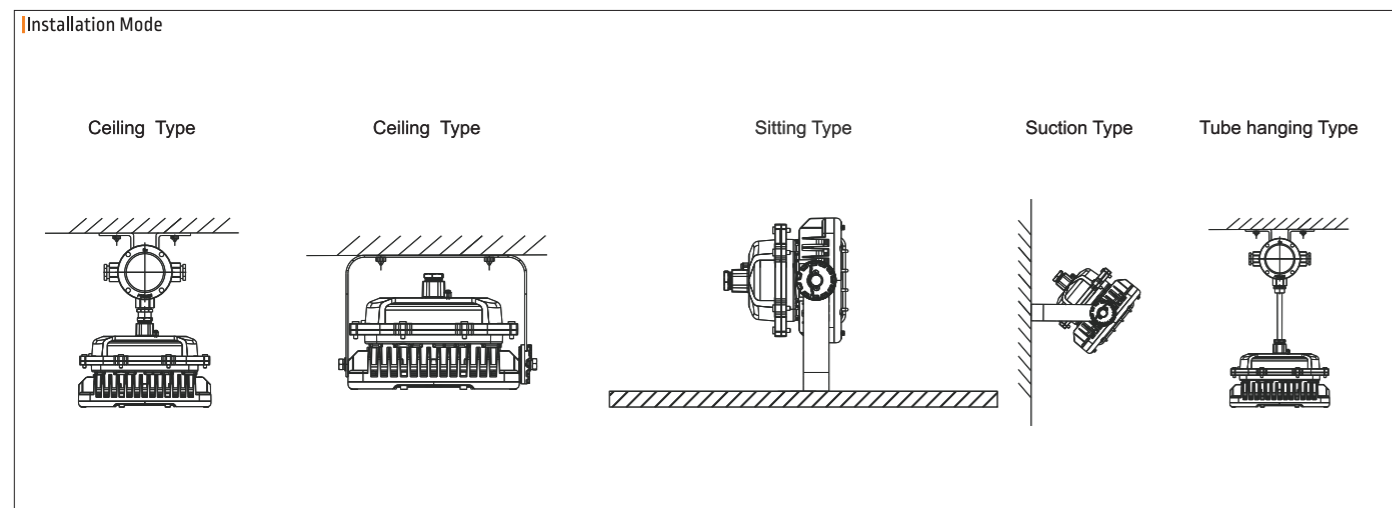
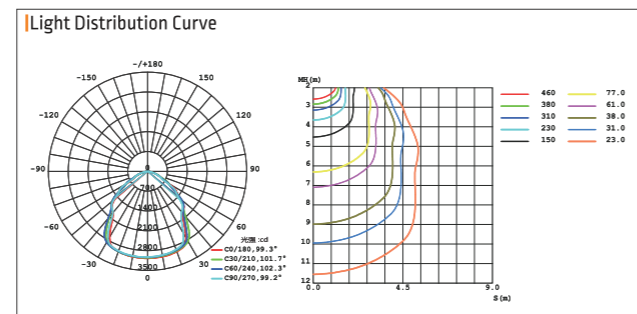
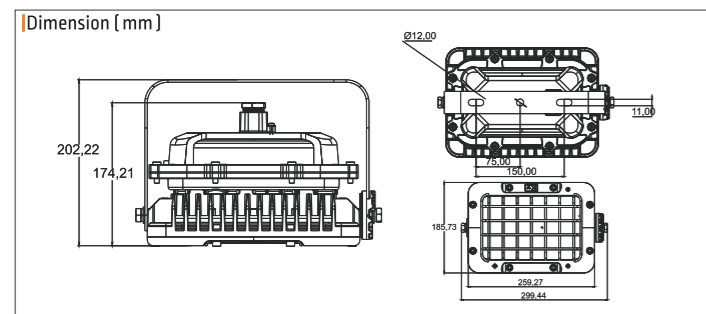

ZERON
NEW LIGHT NEW LIFE

Explosion Proof Zeron OHBF8260-MS



Specification

Executive Standart	Rated Power	Rated Voltage	Weight	Size	Color Rendering	Power Factor	Beam Angle	Protection Level
GB3836.1 GB3836.2	80W 100W 120W 150W	AC100-270V 50/60Hz	8.9kg	ø324X276X165MM	≥75Ra	>0.95	106.5°	IP66
Anticorrosion Grade		Light Effect		Introduction Device		Explosion Proof Mark		
WF2		120Lm/W		G3/4"ø8MM-ø14MM		Ex d IIC T6 Gb/Ex TD A21 T80°C		

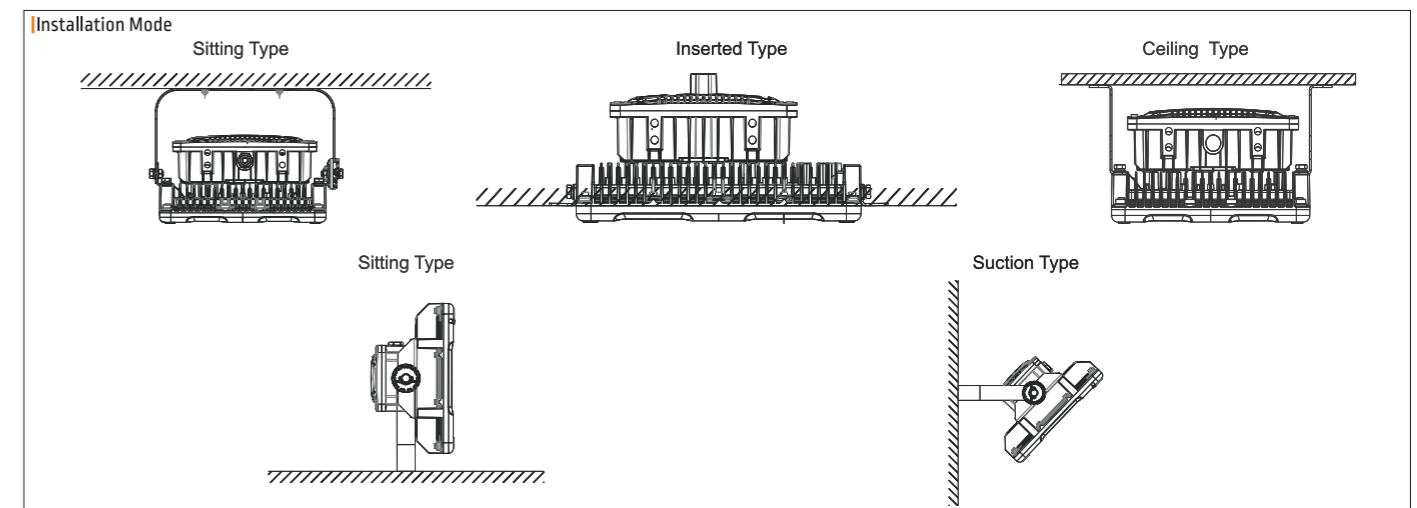
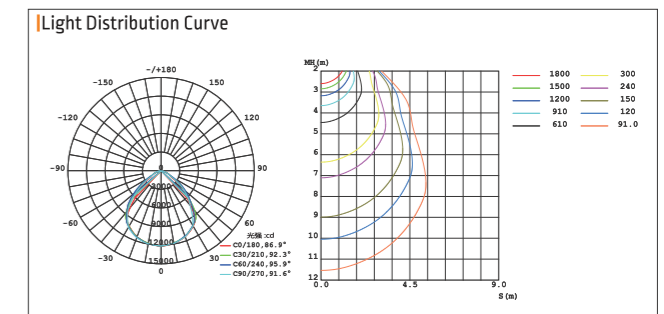
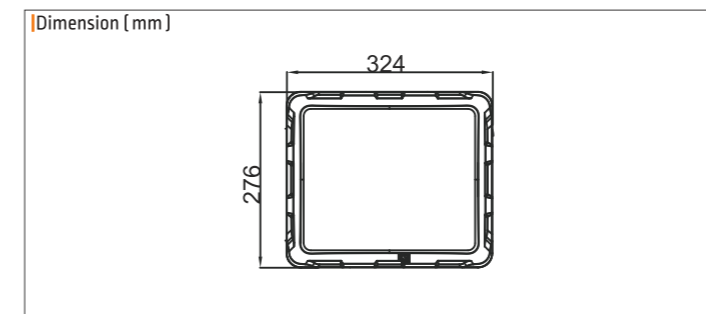

ZERON
NEW LIGHT NEW LIFE

Explosion Proof Zeron OHBF8260-BS

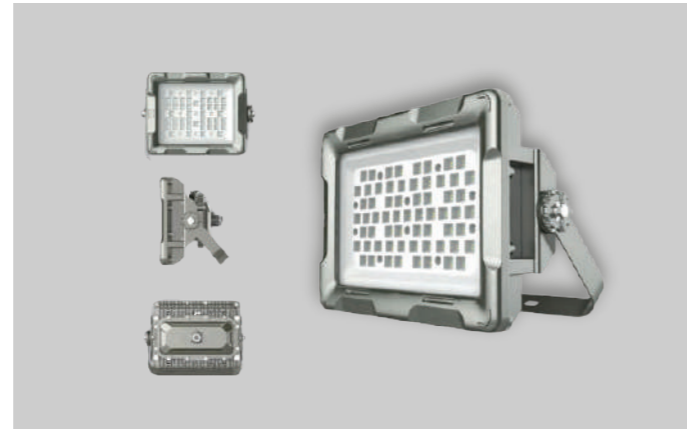

Specification

Executive Standart	Rated Power	Rated Voltage	Weight	Size	Color Rendering	Power Factor	Beam Angle	Protection Level
GB3836.1 GB3836.2	150W 200W 220W 240W	AC100-270V 50/60Hz	9.2kg	ø425X315X165MM	≥75Ra	>0.95	89.4°	IP66
Anticorrosion Grade		Light Effect		Introduction Device		Explosion Proof Mark		
WF2		120Lm/W		G3/4"ø8MM-ø14MM		Ex d IIC T6 Gb/Ex TD A21 T80°C		

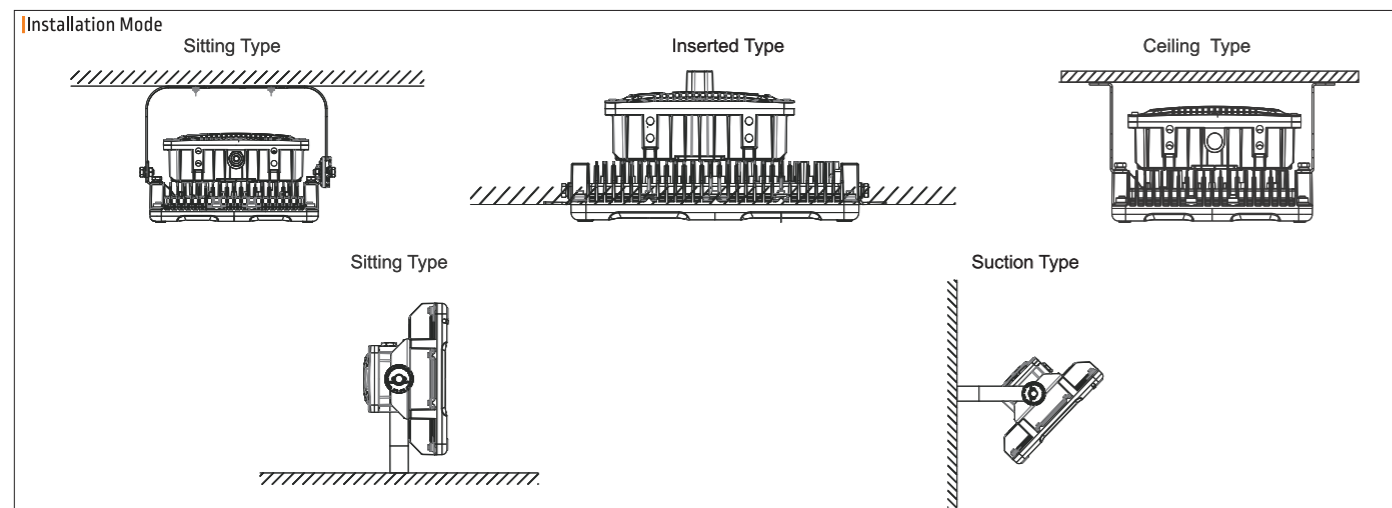
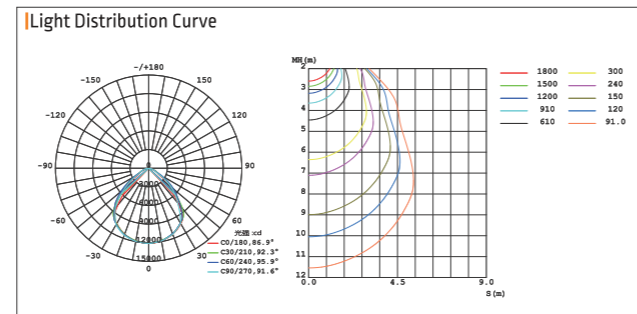
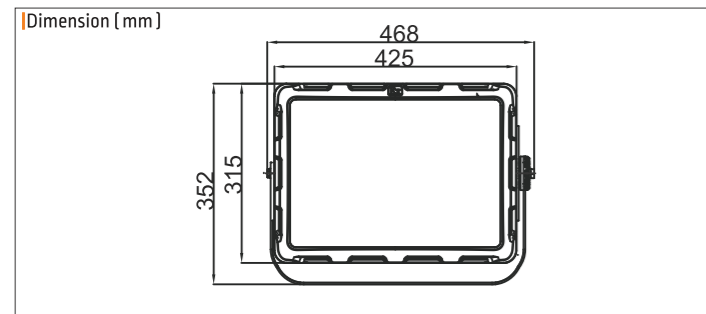

ZERON
NEW LIGHT NEW LIFE

Explosion Proof Zeron OHBF8266-SS



Specification

Executive Standart	Rated Power	Rated Voltage	Weight	Size	Color Rendering	Power Factor	Beam Angle	Protection Level
GB3836.1 GB3836.2	240W 300W 380W	AC100-270V 50/60Hz	14kg	ø552X353X190MM	≥75Ra	>0.95	106.5°	IP66
Anticorrosion Grade		Light Effect		Introduction Device		Explosion Proof Mark		
WF2		120-200Lm/W		G3/4"ø8MM-ø14MM		Ex d IIC T6 Gb/Ex TD A21 T80°C		

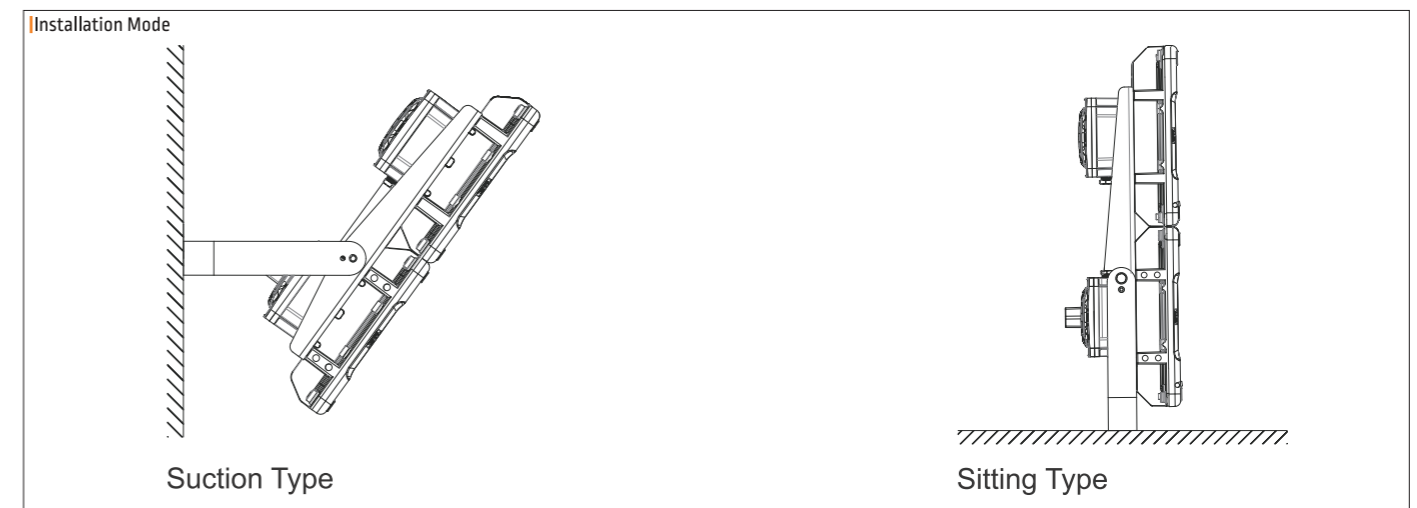
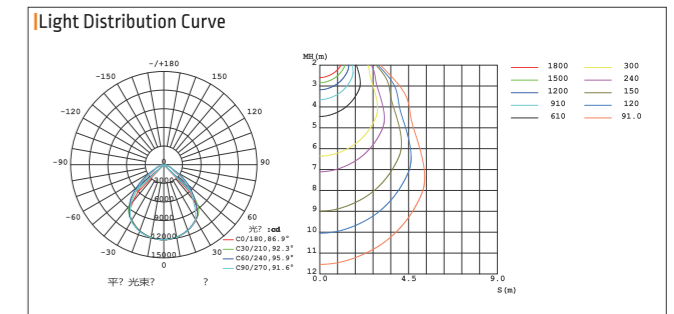
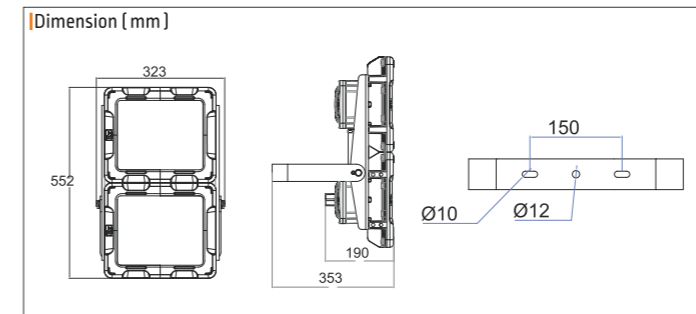

ZERON
NEW LIGHT NEW LIFE

Explosion Proof Zeron
OHBF8266-BS

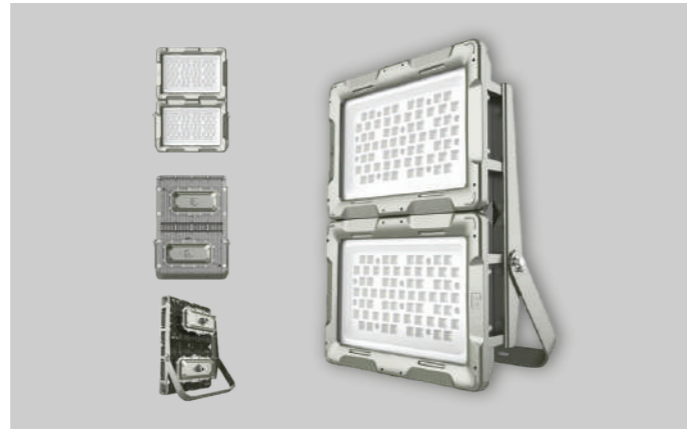

Specification

Executive Standart	Rated Power	Rated Voltage	Weight	Size	Color Rendering	Power Factor	Beam Angle	Protection Level
GB3836.1 GB3836.2	350W 400W 440W 480W	AC100-270V 50/60Hz	28kg	ø630X425X195MM	≥75Ra	>0.95	89.4°	IP66
Anticorrosion Grade		Light Effect		Introduction Device		Explosion Proof Mark		
WF2		120Lm/W		G3/4"ø8MM-ø14MM		Ex d IIC T6 Gb/Ex TD A21 T80°C		

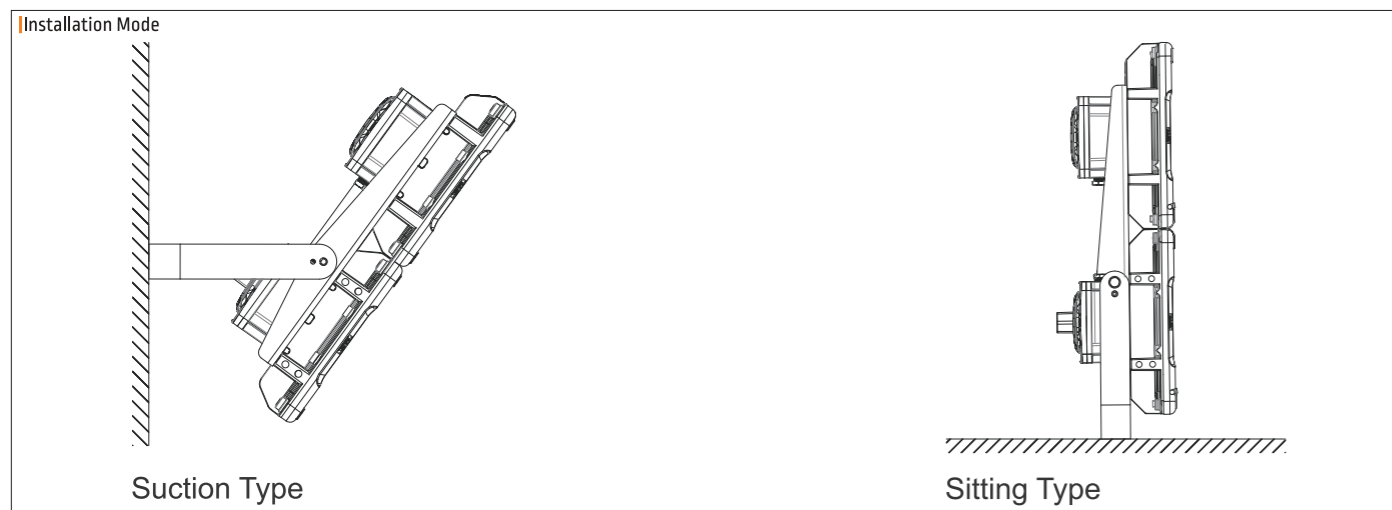
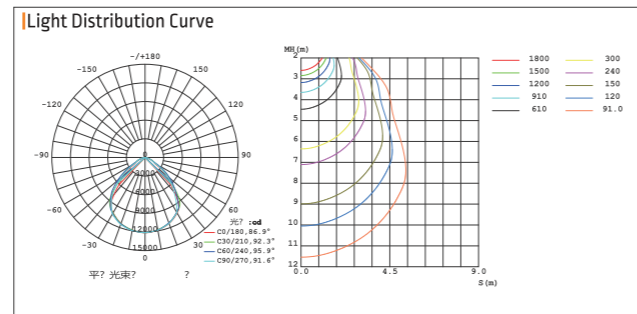
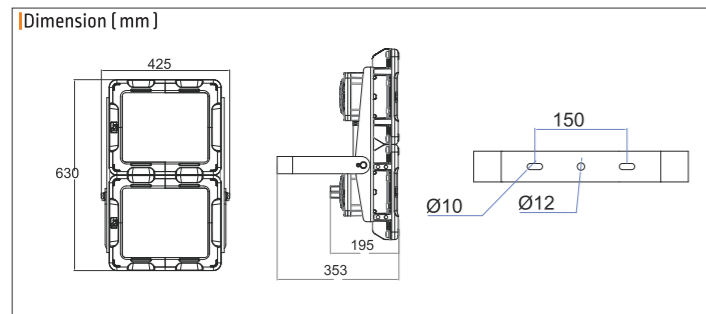

ZERON
NEW LIGHT NEW LIFE

Explosion Proof Zeron
OHBF8189

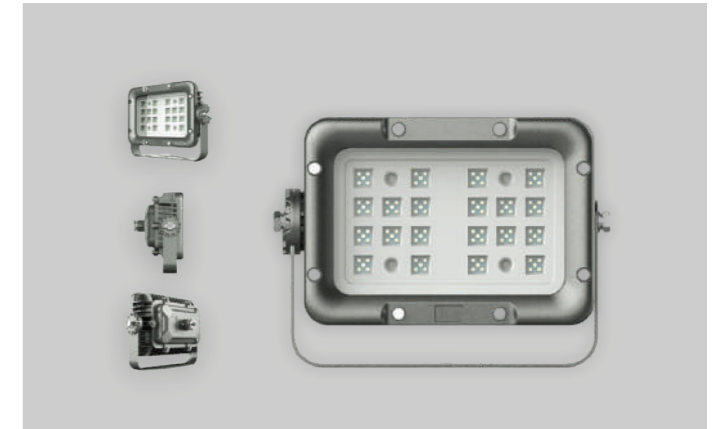

Specification

Executive Standart	Rated Power	Rated Voltage	Weight	Size	Color Rendering	Power Factor	Beam Angle	Protection Level
GB3836.1 GB3836.2	30W 80W	AC220-240V 50/60Hz	3.3kg	ø299X186X174MM	≥70Ra	>0.95	100°	IP66
Anticorrosion Grade		Light Effect		Introduction Device		Explosion Proof Mark		
WF2		120Lm/W		G2/4"ø8MM-ø14MM		Ex d IIC T6 Gb/Ex TD A21 T80°C		

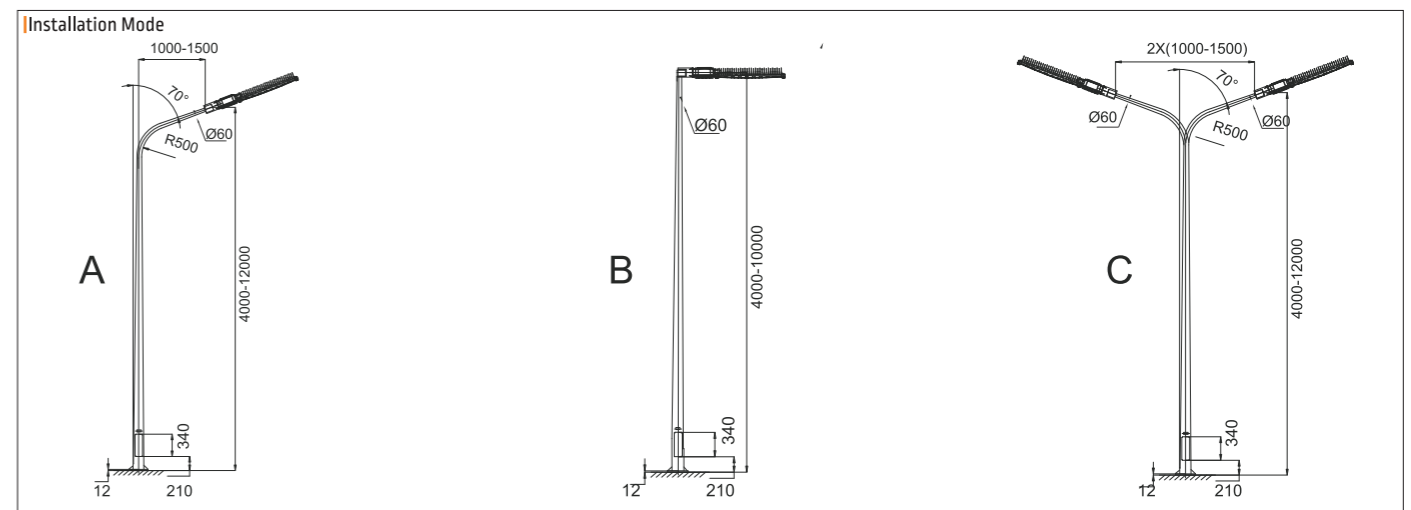
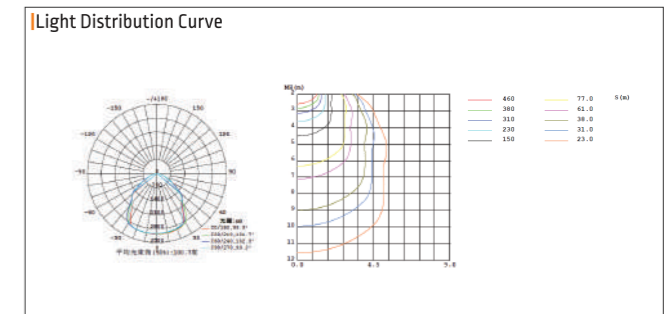
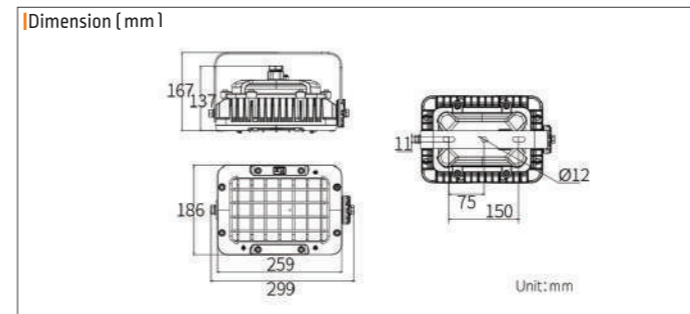

ZERON
NEW LIGHT NEW LIFE

Explosion Proof Zeron OHBF8269-SL

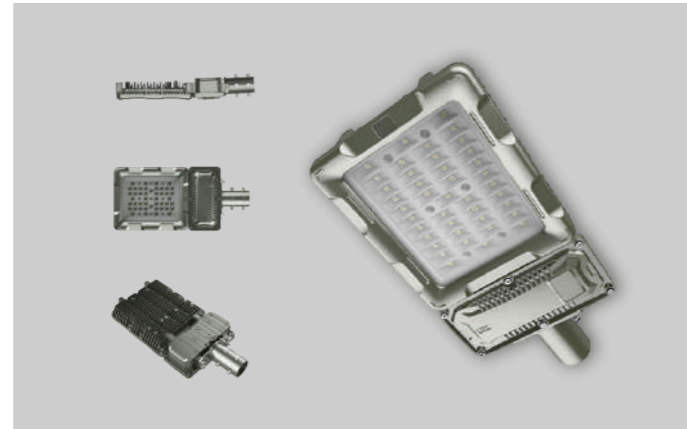

Specification

Executive Standart	Rated Power	Rated Voltage	Weight	Size	Color Rendering	Power Factor	Beam Angle	Protection Level
GB3836.1 GB3836.2	100W 120W 150W 180W	AC100-270V 50/60Hz	75kg	ø276X590X95MM	≥70Ra	>0.95	106.5°	IP66
Anticorrosion Grade		Light Effect		Introduction Device		Explosion Proof Mark		
WF2		120lm/W		65MM		Ex d IIC T6 Gb/Ex TD A21 T80°C		

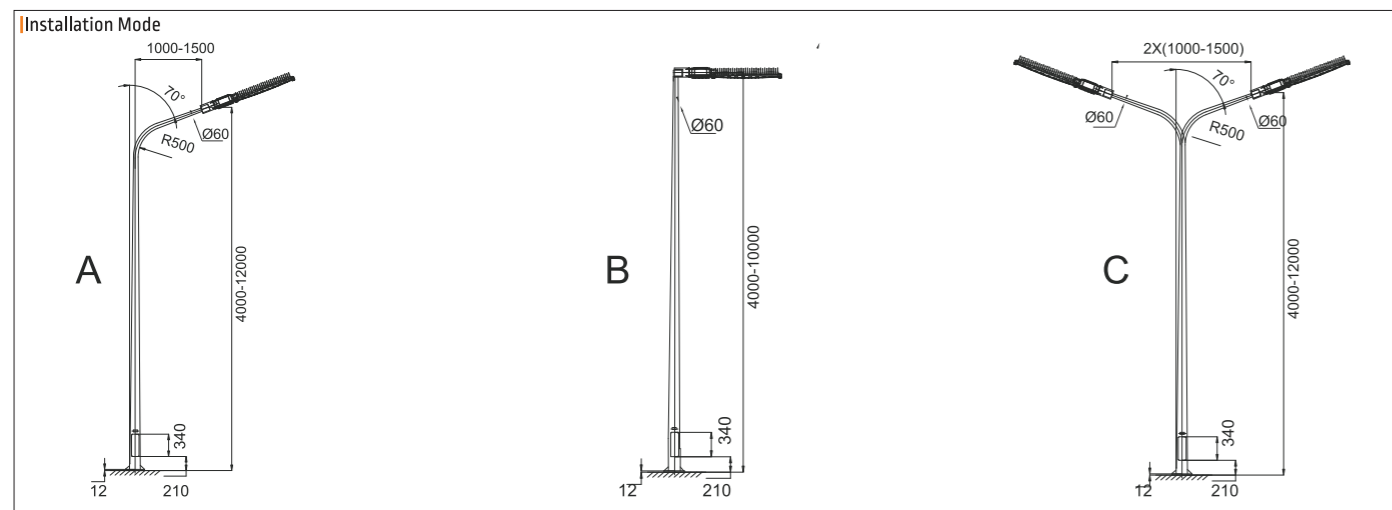
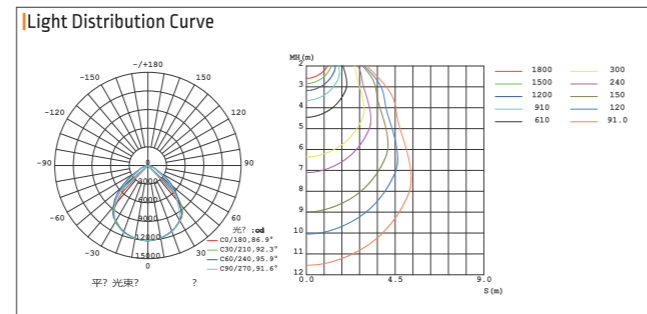
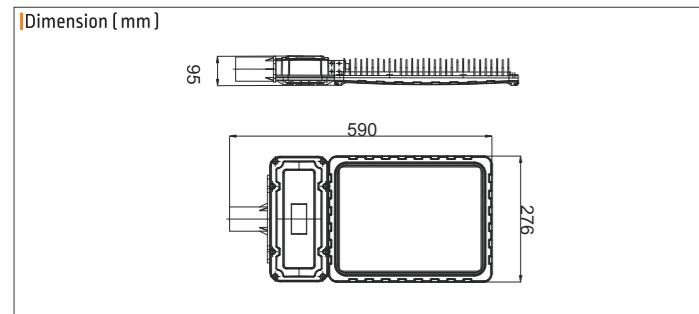

ZERON
NEW LIGHT NEW LIFE

Explosion Proof Zeron OHBF8191

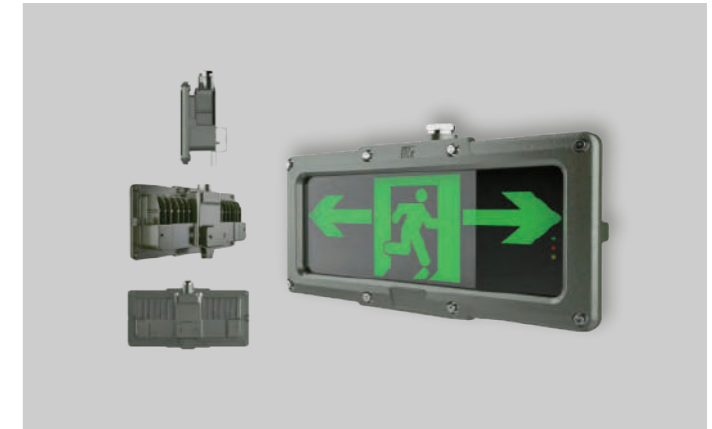

Specification

Executive Standart	Rated Power	Rated Voltage	Weight	Size	Color Rendering	Cable Entry	Discharger Time	Protection Level
GB3836.1 GB3836.2 GB12476.1 GB12476.5	3W	AC100-273V 50/60Hz	2.8kg	ø350X182X76.4MM	≥75Ra	ø8MM-ø14MM	120MIN	IP66
Anticorrosion Grade		Charging Time		Introduction Device		Explosion Proof Mark		
WF2		48H		G3/4"ø8MM-ø14MM		Ex d IIB T6		

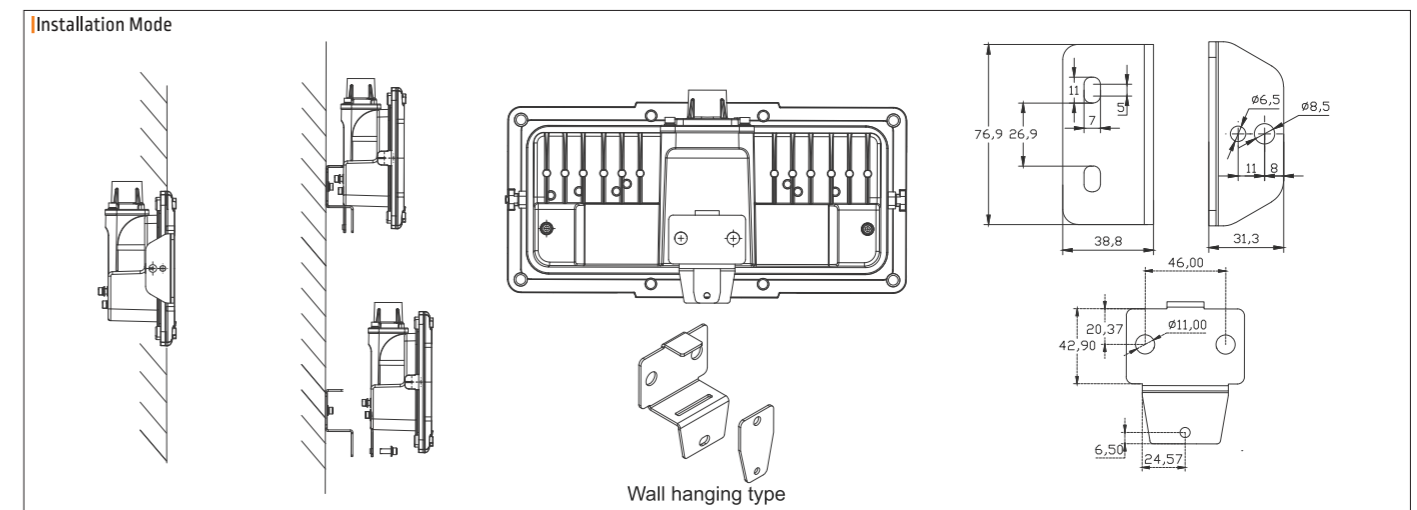
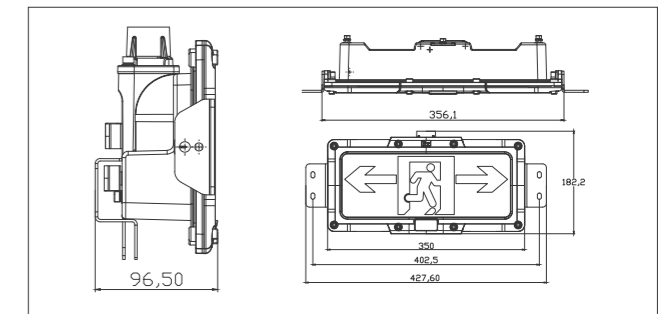
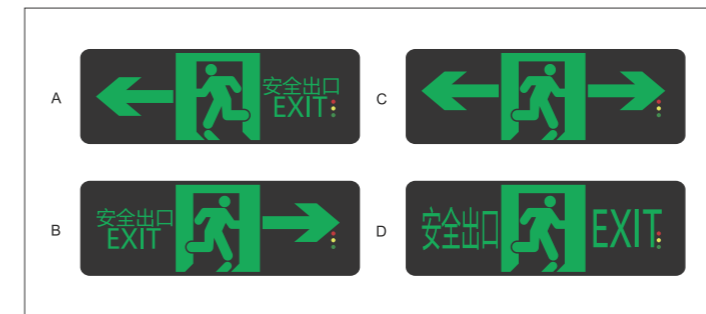

ZERON
NEW LIGHT NEW LIFE

Explosion Proof Zeron OHBF8190

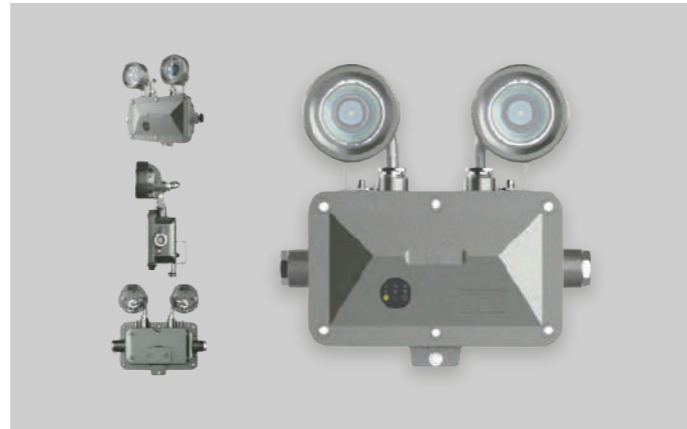

Specification

Executive Standart	Rated Power	Rated Voltage	Weight	Size	Color Rendering	Discharger Time	Cable Entry	Protection Level
GB3836.1 GB3836.2 GB12476.1 GB12476.5	2X3W	AC110-273V 50/60Hz	2.5kg	ø230X260X85MM	≥75Ra	120MIN	ø8MM-ø14MM	IP66
Anticorrosion Grade		Introduction Device			Explosion Proof Mark			
WF2		G3/4" ø8MM-ø14MM			Ex d IIB T6			

Dimension (mm)

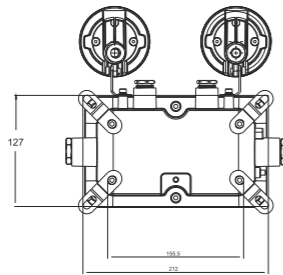

Installation Mode

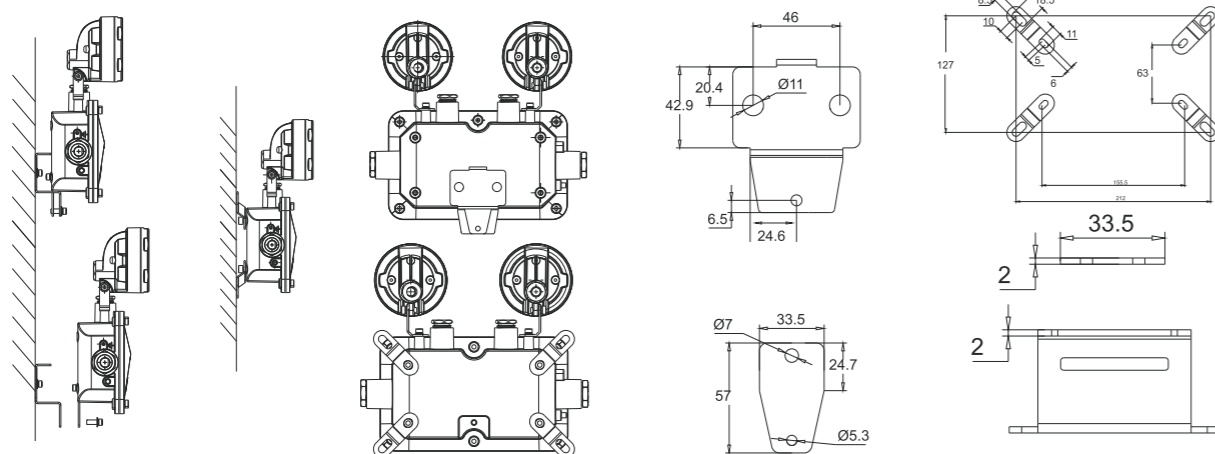

ZERON
NEW LIGHT NEW LIFE

Explosion Proof Zeron OHBF51S & OHBF51D



Specification

Executive Standart	Rated Power	Rated Voltage	Weight	Size	Color Rendering	Power Factor	Protection Level
GB3836.1 GB3836.2	1X18W 2X18W	AC110-270V 50/60Hz	2.6kg 4.6kg	ø1280X123X146MM ø1300X202X146MM	≥75Ra	>0.95	IP65
Anticorrosion Grade		Light Effect		Introduction Device		Explosion Proof Mark	
WF2		120-200Lm/W		G3/4" ø88MM-ø14MM		Ex nR II T6 Gc/Ex tD A21	

Dimension (mm)

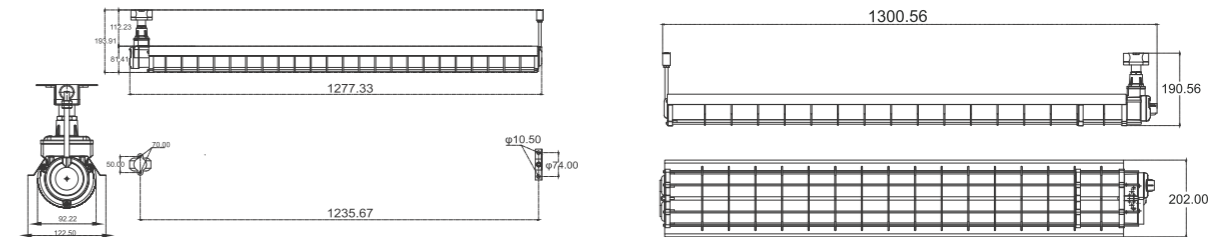

Installation Mode

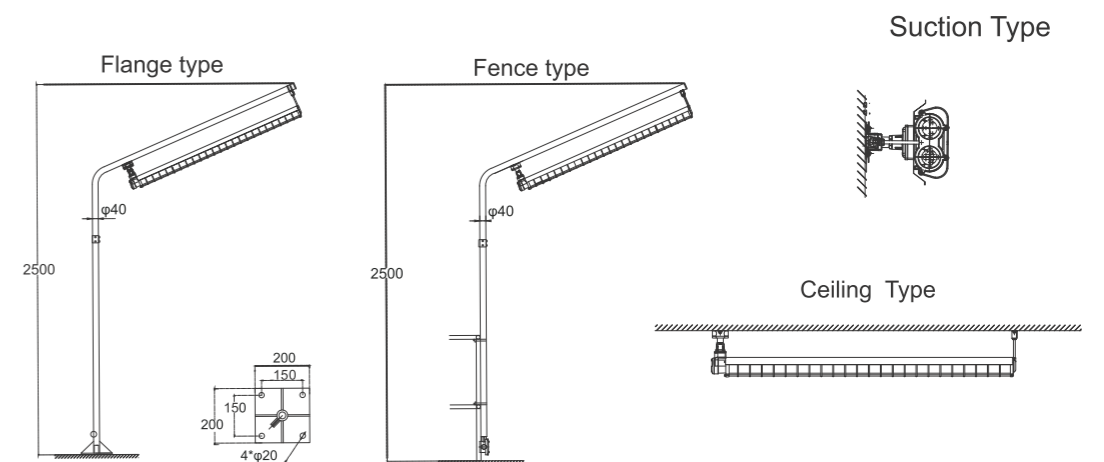

ZERON
NEW LIGHT NEW LIFE

Explosion Proof Zeron

OHBF8192

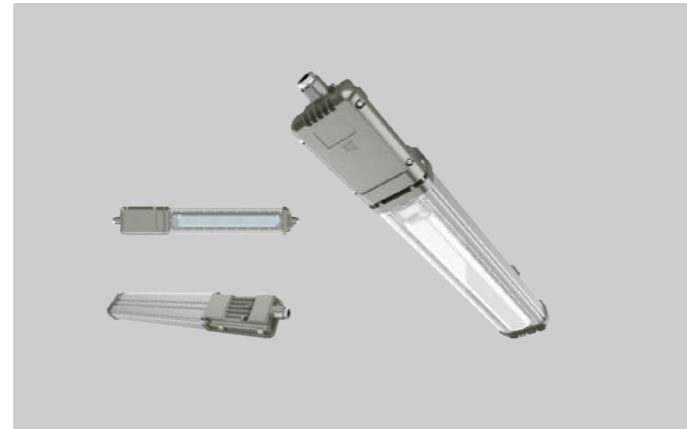

Specification

Executive Standart	Rated Power	Rated Voltage	Weight	Size	Color Rendering	Power Factor	Beam Angle	Protection Level
GB3836.2 GB3836.9	20W 40W 60W	AC170-247V 50/60Hz	4.1kg	ø812X125X77MM	≥70Ra	>0.95	120°	IP66
Anticorrosion Grade		Light Effect		Total Lumen		Explosion Proof Mark		
WF2		120Lm/W		2.400Lm 4.800Lm 7.200Lm		Ex nR IIC T6 Gc/Ex tD A21 IP66 T80°C		

Dimension (mm)

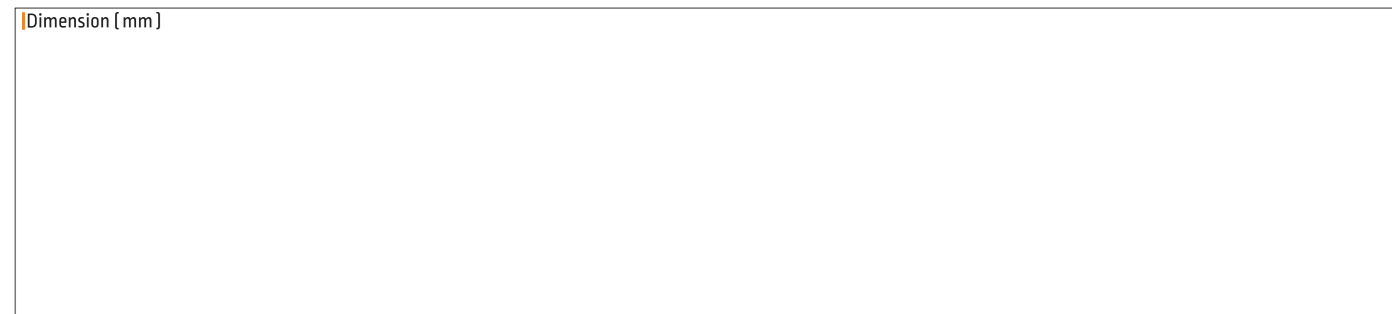

Installation Mode

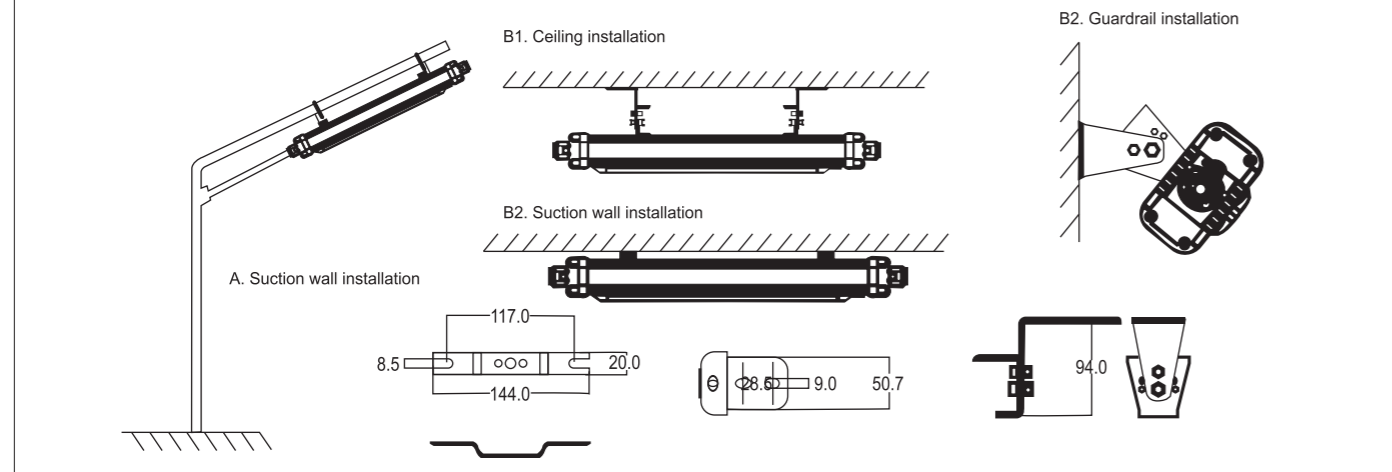

ZERON
NEW LIGHT NEW LIFE

Explosion Proof Zeron

OHBF8192-600

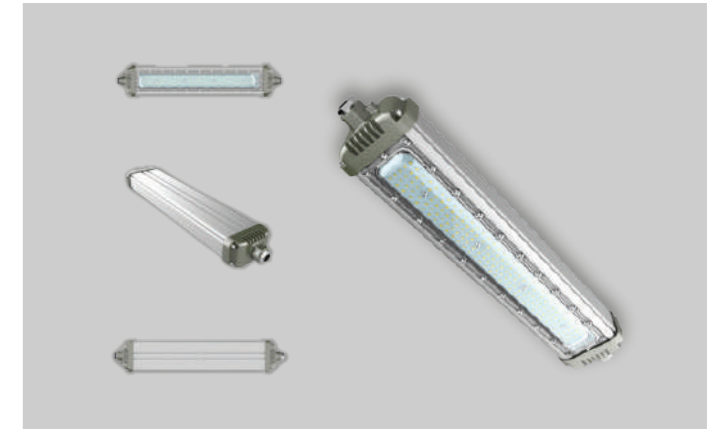

Specification

Executive Standart	Rated Power	Rated Voltage	Weight	Size	Color Rendering	Power Factor	Beam Angle	Protection Level
GB3836.2 GB3836.9	20W 40W 60W	AC220-240V 50/60Hz	2.9kg	ø635X125X77MM	≥75Ra	>0.95	120 Deg	IP66
Anticorrosion Grade		Light Effect		Introduction Device		Explosion Proof Mark		
WF2		120Lm/W		2400Lm 4800Lm 7200Lm		Ex nR IIC T6 Gc/Ex tD A21 IP66 T80°C		

Dimension (mm)

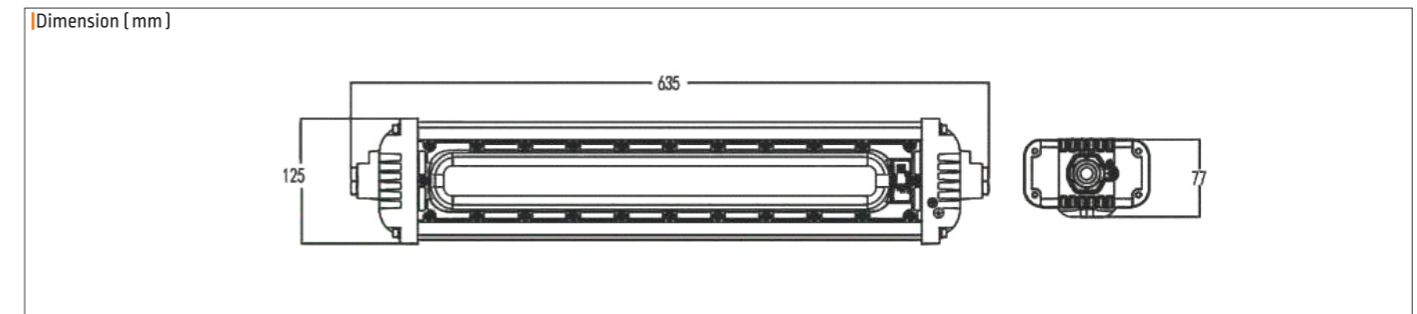

Installation Mode

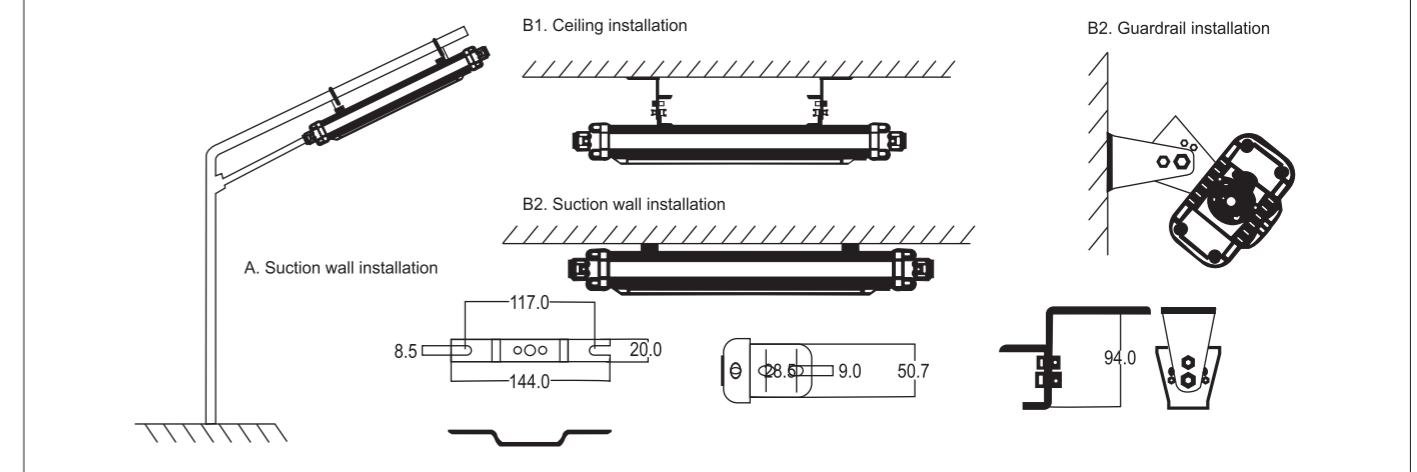

ZERON
NEW LIGHT NEW LIFE

Explosion Proof Zeron

OHBF8192-1200

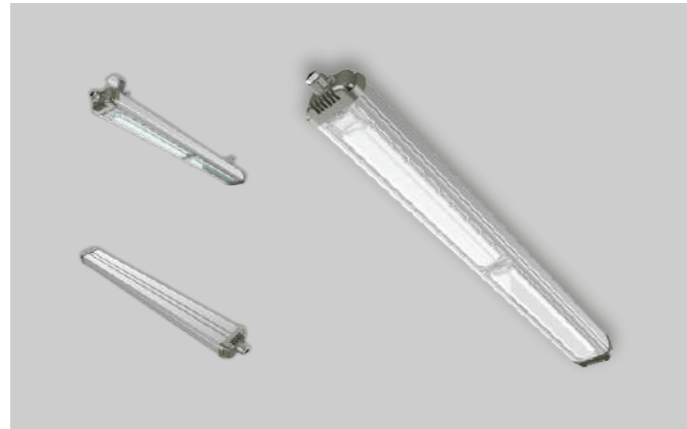

INGROUND LIGHT

Specification

Executive Standart	Rated Power	Rated Voltage	Weight	Size	Color Rendering	Power Factor	Beam Angle	Protection Level
GB3836.2 GB3836.9	70W 100W 120W	AC220-240V 50/60Hz	4.9kg	ø1143X125X77MM	≥70Ra	>0.95	240 Deg	IP66
Anticorrosion Grade		Light Effect		Introduction Device		Explosion Proof Mark		
WF2		120Lm/W		G3/4" ø8MM-ø14MM		Ex nR IIC T6 Gc/Ex tD A21 IP66 T80°C		

Dimension (mm)

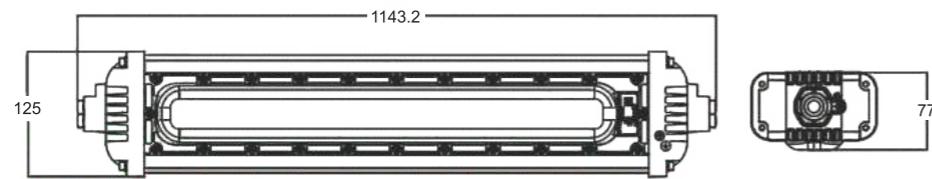

Installation Mode

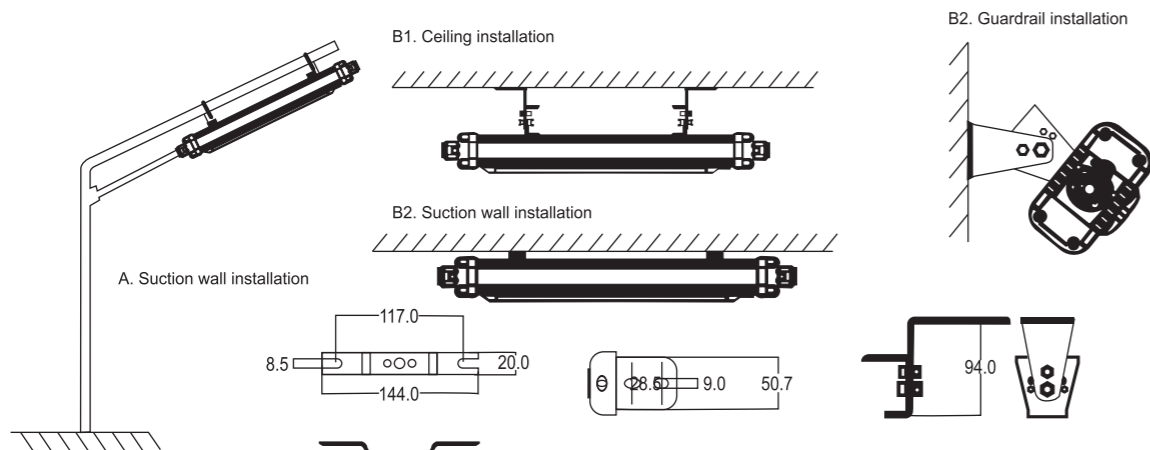

ZERON
NEW LIGHT NEW LIFE

Inground Light
ZERN-UGL-2,5W



Specification

Daya (W)	Input Voltage	Frequency Amp	LED Efikasi	Total Lumen	CRI	Temperatur Warna	Proteksi	Material
2,5W	DC 12V, 24V / AC 220V	50/60Hz	100Lm/W	250Lm	>80Ra (>90Ra Optional)	3000K-6000K, RGB	IP67	Die-casting grey powder coated aluminum

Model : ZERN-UGL-2,5W

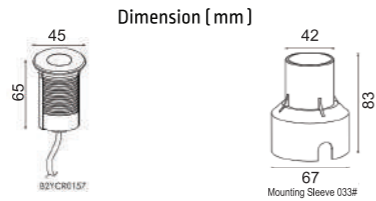

Optional Accessories



3.000K 4.000K 5.000K 6.000K

ZERON
NEW LIGHT NEW LIFE

Inground Light
ZERN-UGL-12W



Specification

Daya (W)	Input Voltage	Frequency Amp	LED Efikasi	Total Lumen	CRI	Temperatur Warna	Proteksi	Material
12W	DC 12V, 24V / AC 220V	50/60Hz	100Lm/W	1.200Lm	>80Ra (>90Ra Optional)	3000K-6000K, RGB	IP67	Aluminium

Model : ZERN-UGL-12W

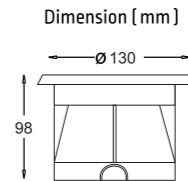

Application



3.000K 4.000K 5.000K 6.000K

ZERON
NEW LIGHT NEW LIFE

Inground Light
ZERN-UGLR-6W



Specification

Daya (W)	Input Voltage	Frequency Amp	LED Efikasi	Total Lumen	CRI	Temperatur Warna	Proteksi	Material
6W	DC 12V, 24V / AC 220V	50/60Hz	100Lm/W	600Lm	>80Ra (>90Ra Optional)	3000K-6000K, RGB	IP67	Die-casting grey powder coated aluminum

Model : ZERN-UGLR-6W

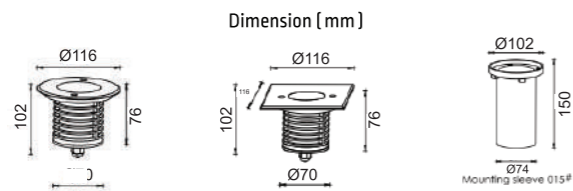

Optional Accessories

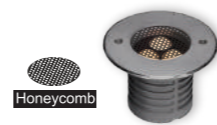

3.000K 4.000K 5.000K 6.000K

ZERON
NEW LIGHT NEW LIFE

Inground Light
ZERN-UGLR-13W



Specification

Daya (W)	Input Voltage	Frequency Amp	LED Efikasi	Total Lumen	CRI	Temperatur Warna	Proteksi	Material
13W	DC 12V, 24V / AC 220V	50/60Hz	100Lm/W	1.300Lm	>80Ra (>90Ra Optional)	3000K-6000K, RGB	IP67	Die-casting grey powder coated aluminum

Model : ZERN-UGLR-13W

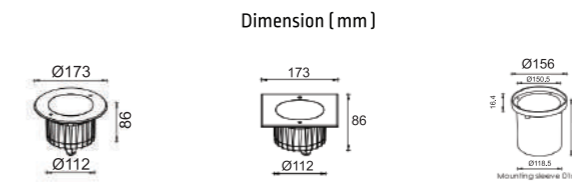
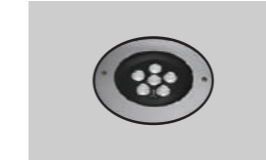

Optional Accessories

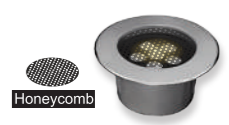

3.000K 4.000K 5.000K 6.000K

* Easy maintenance
- Modular LED for easy replacement
- Opening and closing possible of LED module part and power supply part
- Customizable beam angle
- Temperature max 50°



* Easy maintenance
- Modular LED for easy replacement
- Opening and closing possible of LED module part and power supply part
- Customizable beam angle
- Temperature max 50°



ZERON
NEW LIGHT NEW LIFE

Inground Light
ZERN-UGLS-6W



Specification

Daya (W)	Input Voltage	Frequency Amp	LED Efikasi	Total Lumen	CRI	Temperatur Warna	Proteksi	Material
6W	DC 12V, 24V / AC 220V	50/60Hz	100Lm/W	600Lm	>80Ra (>90Ra Optional)	3000K-6000K, RGB	IP67	Die-casting grey powder coated aluminum

Model : ZERN-UGLS-6W

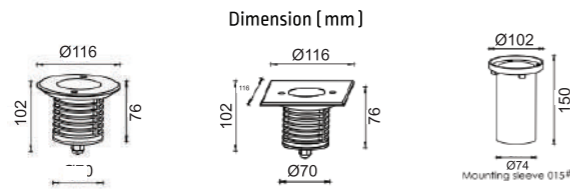

Optional Accessories



ZERON
NEW LIGHT NEW LIFE

Inground Light
ZERN-UGLS-13W



Specification

Daya (W)	Input Voltage	Frequency Amp	LED Efikasi	Total Lumen	CRI	Temperatur Warna	Proteksi	Material
13W	DC 12V, 24V / AC 220V	50/60Hz	100Lm/W	1.300Lm	>80Ra (>90Ra Optional)	3000K-6000K, RGB	IP67	Die-casting grey powder coated aluminum

Model : ZERN-UGLS-13W

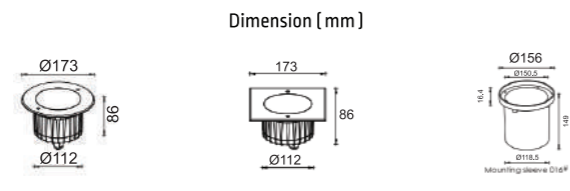

Optional Accessories

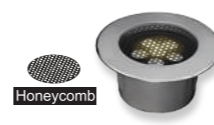

- * Easy maintenance
- Modular LED for easy replacement
- Opening and closing possible of LED module part and power supply part
- Customizable beam angle
- Temperature max 50°



ZERON
NEW LIGHT NEW LIFE

Wall Washer
ZERN-ASMG19002



Specification

Daya (W)	Input Voltage	Frequency Amp	LED Efikasi	Total Lumen	CRI	Temperatur Warna	Proteksi	Material
6W / 12W	DC 12V, 24V / AC 220V	50/60Hz	130Lm/W	780Lm / 1.560Lm	>80Ra (>90Ra Optional)	3000K-6000K, RGB	IP65	Aluminium+PC

Model : ZERN-ASMG19002-6W



Dimension [mm]

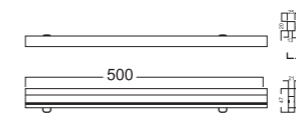

Model : ZERN-ASMG19002-12W



Dimension [mm]

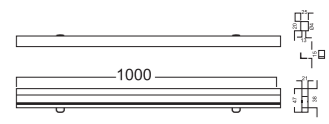

ZERON
NEW LIGHT NEW LIFE

Wall Washer
ZERN-ASMG21001



Specification

Daya (W)	Input Voltage	Frequency Amp	LED Efikasi	Total Lumen	CRI	Temperatur Warna	Proteksi	Material
6W / 12W	DC 12V, 24V / AC 220V	50/60Hz	100Lm/W	600Lm / 1.200Lm	>80Ra (>90Ra Optional)	3000K-6000K, RGB	IP65	Aluminium+PC

Model : ZERN-ASMG21001-6W



Dimension [mm]

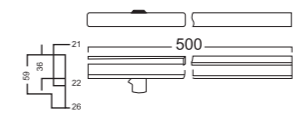

Model : ZERN-ASMG21001-12W



Dimension [mm]

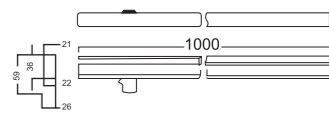

- * Easy maintenance
- Modular LED for easy replacement
- Opening and closing possible of LED module part and power supply part
- Customizable beam angle
- Temperature max 50°



ZERON
NEW LIGHT NEW LIFE

Wall Washer

ZERN-ASMG17001



■ Specification

Daya (W)	Input Voltage	Frequency Amp	LED Efikasi	Total Lumen	CRI	Temperatur Warna	Proteksi	Material
6W / 12W	DC 12V, 24V / AC 220V	50/60Hz	100Lm/W	600Lm / 1.200Lm	>80Ra (>90Ra Optional)	3000K-6000K, RGB	IP65	Aluminium+PC

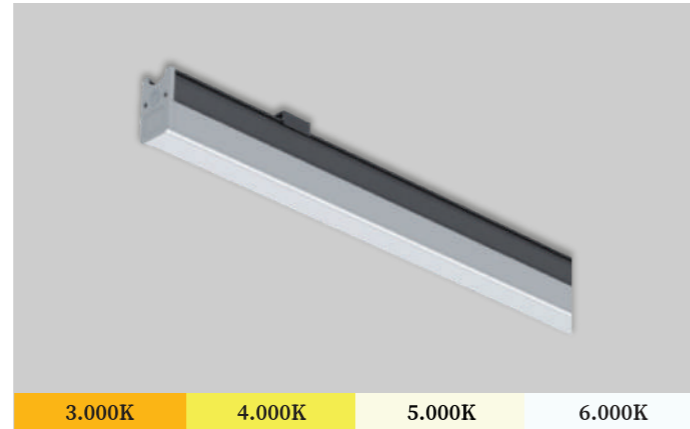

Model : ZERN-ASMG17001-6W

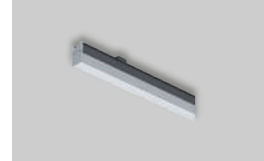

Dimension (mm)

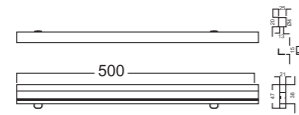

Model : ZERN-ASMG17001-12W

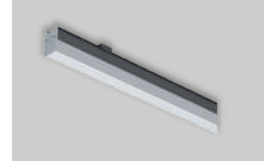

Dimension (mm)

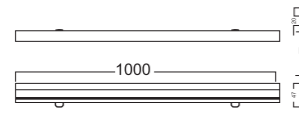

Application



- * Easy maintenance
- Modular LED for easy replacement
- Opening and closing possible of LED module part and power supply part
- Customizable beam angle
- Temperature max 50°



ZERON
NEW LIGHT NEW LIFE

Wall Washer

ZERN-ALTD



■ Specification

Daya (W)	Input Voltage	Frequency Amp	LED Efikasi	Total Lumen	CRI	Temperatur Warna	Proteksi	Material
18W 24W 36W	DC 12V, 24V / AC 220V	50/60Hz	100Lm/W	1.800Lm 2.400Lm 3.600Lm	>80Ra (>90Ra Optional)	3000K-6000K, RGB	IP65	Aluminium+PC

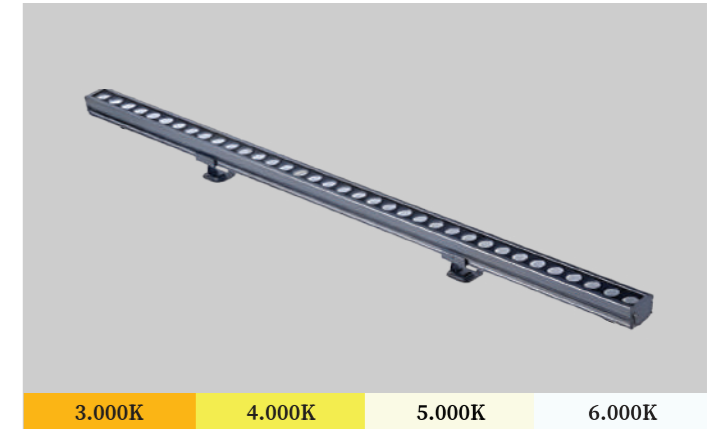

Model : ZERN-ALTD35018

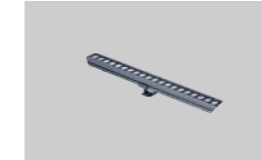

Dimension (mm)

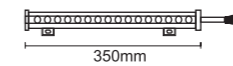

Model : ZERN-ALTD51024

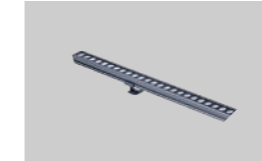

Dimension (mm)

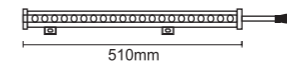

Model : ZERN-ALTD100036



Dimension (mm)

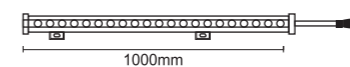

Application



- * Easy maintenance
- Modular LED for easy replacement
- Opening and closing possible of LED module part and power supply part
- Customizable beam angle
- Temperature max 50°





UNDERWATER LIGHT

ZERON NEW LIGHT NEW LIFE

Underwater Light ZERN-UWL-2,6W



■ Specification

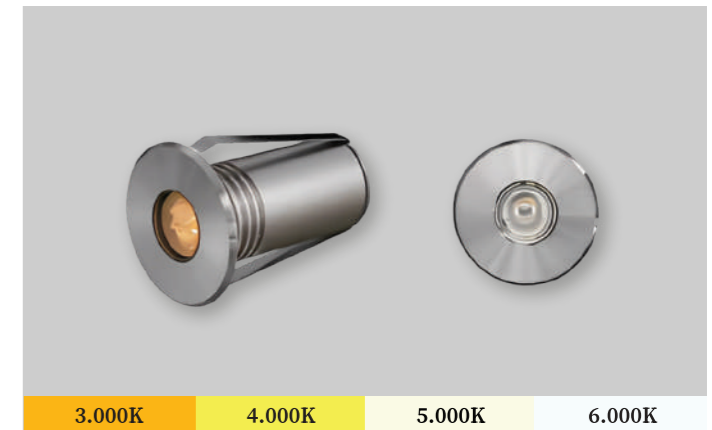

Daya (W)	Input Voltage	Frequency Amp	LED Efikasi	Total Lumen	CRI	Temperatur Warna	Proteksi	Material
2,6W	DC 12V, 24V	50/60Hz	100Lm/W	260Lm	>80Ra [>90Ra Optional]	3000K-6000K, RGB	IP68	Hard chromeplated molding shaped stainless steel

Model : ZERN-UWL-2,6W

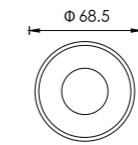
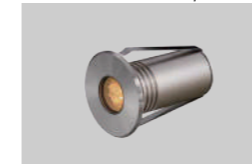

Dimension [mm]

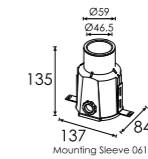
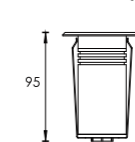

Light Distribution Curve

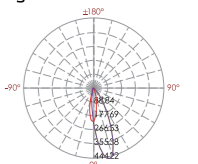

ZERON NEW LIGHT NEW LIFE

Underwater Light ZERN-UWL-8,9W



■ Specification



Daya (W)	Input Voltage	Frequency Amp	LED Efikasi	Total Lumen	CRI	Temperatur Warna	Proteksi	Material
8,9W	DC 12V, 24V	50/60Hz	100Lm/W	890Lm	>80Ra [>90Ra Optional]	3000K-6000K, RGB	IP68	Hard chromeplated molding shaped stainless steel

Model : ZERN-UWL-8,9W

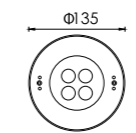

Dimension [mm]

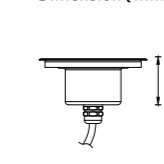

Light Distribution Curve

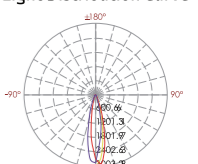

- * Easy maintenance
- Modular LED for easy replacement
- Opening and closing possible of LED module part and power supply part
- Customizable beam angle
- Temperature max 50°



ZERON
NEW LIGHT NEW LIFE

Underwater Light
ZERN-UWL-16,8W



Specification

Daya (W)	Input Voltage	Frequency Amp	LED Efikasi	Total Lumen	CRI	Temperatur Warna	Proteksi	Material
16,8W	DC 12V, 24V	50/60Hz	100Lm/W	1.680Lm	>80Ra [>90Ra Optional]	3000K-6000K, RGB	IP68	Hard chromeplated molding shaped stainless steel

Model : ZERN-UWL-16,8W

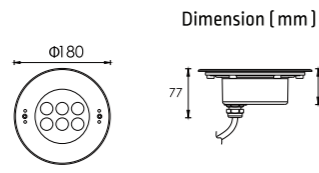

ZERON
NEW LIGHT NEW LIFE

Underwater Light
ZERN-UWL-28,8W

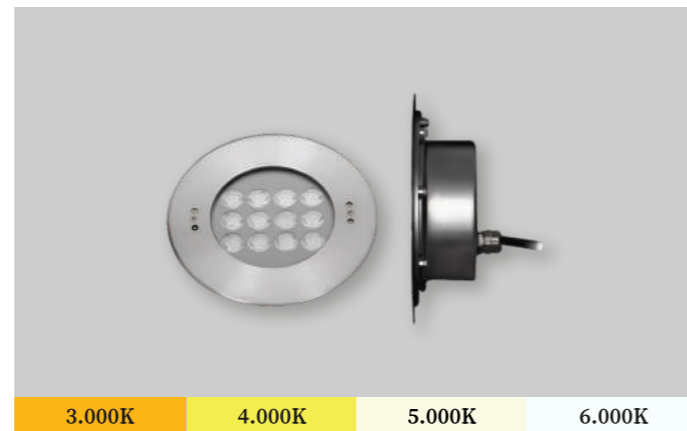

Specification

Daya (W)	Input Voltage	Frequency Amp	LED Efikasi	Total Lumen	CRI	Temperatur Warna	Proteksi	Material
28,8W	DC 12V, 24V	50/60Hz	100Lm/W	2.880Lm	>80Ra [>90Ra Optional]	3000K-6000K, RGB	IP68	Hard chromeplated molding shaped stainless steel

Model : ZERN-UWL-28,8W

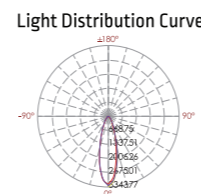
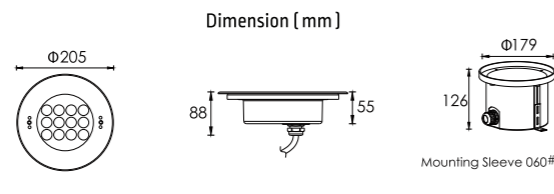

- * Easy maintenance
- Modular LED for easy replacement
- Opening and closing possible of LED module part and power supply part
- Customizable beam angle
- Temperature max 50°



ZERON
NEW LIGHT NEW LIFE

Underwater Light
ZERN-UWL-45,6W



Specification

Daya (W)	Input Voltage	Frequency Amp	LED Efikasi	Total Lumen	CRI	Temperatur Warna	Proteksi	Material
45,6W	DC 12V, 24V	50/60Hz	100Lm/W	4.650Lm	>80Ra [>90Ra Optional]	3000K-6000K, RGB	IP68	Hard chromeplated molding shaped stainless steel

Model : ZERN-UWL-45,6W

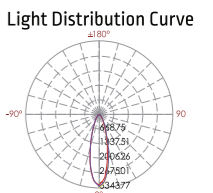
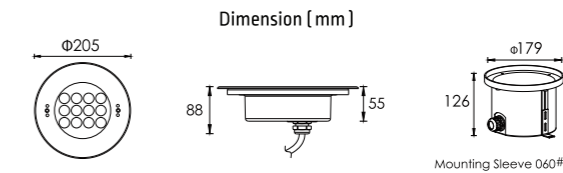

ZERON
NEW LIGHT NEW LIFE

Underwater Light
ZERN-UWLH-15,5W

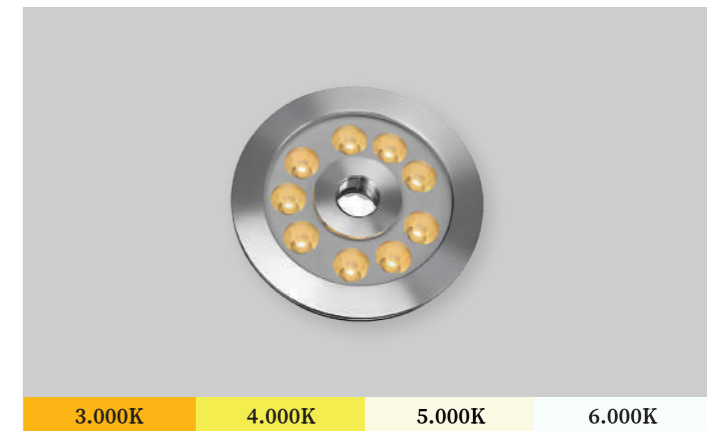

Specification

Daya (W)	Input Voltage	Frequency Amp	LED Efikasi	Total Lumen	CRI	Temperatur Warna	Proteksi	Material
15,5W	DC 12V, 24V	50/60Hz	100Lm/W	1.550Lm	>80Ra [>90Ra Optional]	3000K-6000K, RGB	IP68	Hard chromeplated molding shaped stainless steel

Model : ZERN-UWLH-15,5W

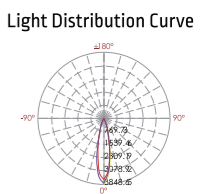
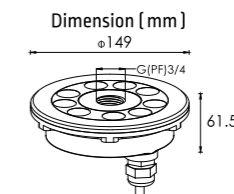

- * Easy maintenance
- Modular LED for easy replacement
- Opening and closing possible of LED module part and power supply part
- Customizable beam angle
- Temperature max 50°



ZERON
NEW LIGHT NEW LIFE

Underwater Light
ZERN-UWLH-28,8W



Specification

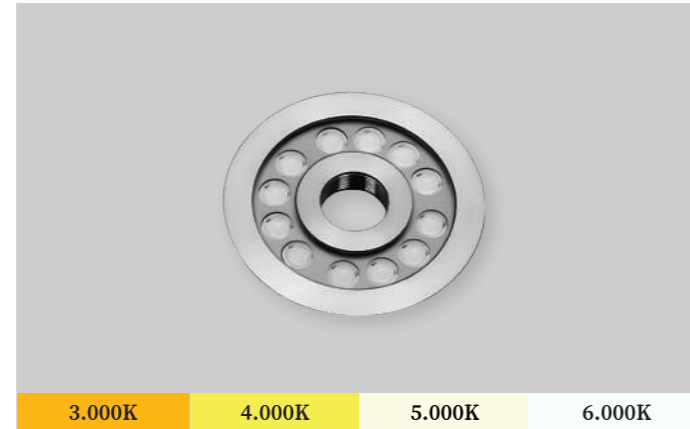

Daya (W)	Input Voltage	Frequency Amp	LED Efikasi	Total Lumen	CRI	Temperatur Warna	Proteksi	Material
28,8W	DC 12V, 24V	50/60Hz	100Lm/W	2.880Lm	>80Ra (>90Ra Optional)	3000K-6000K, RGB	IP68	Hard chromeplated molding shaped stainless steel

Model : ZERN-UWLH-28,8W

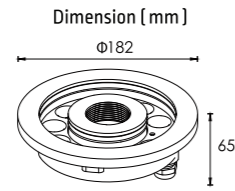

Light Distribution Curve

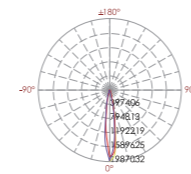

Application

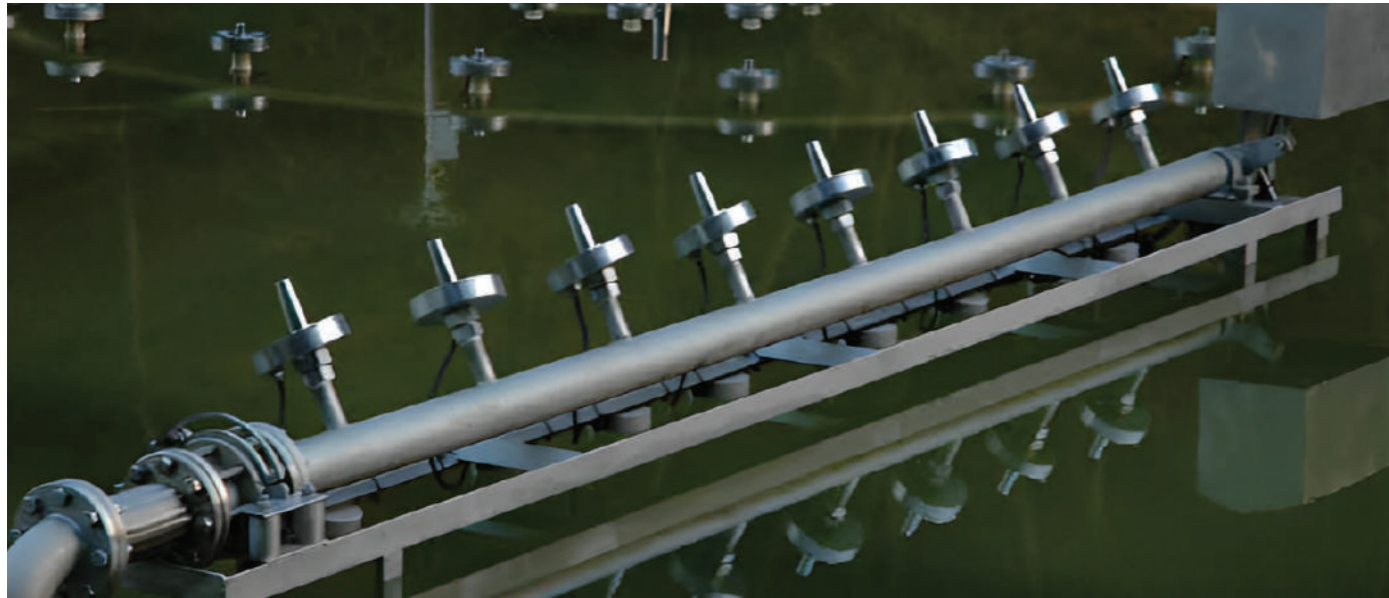

- * Easy maintenance
- Modular LED for easy replacement
- Opening and closing possible of LED module part and power supply part
- Customizable beam angle
- Temperature max 50°



ZERON
NEW LIGHT NEW LIFE

Underwater Light
ZERN-RC-SS160L



Specification



Model	Daya (W)	Input Voltage	Frequency Amp	LED Efikasi	Total Lumen	CRI	Temperatur Warna	Controller	Proteksi	Material
ZERN-RC-SS160L	3W	DC 12V, 24V	50/60Hz	100Lm/W	300Lm	>80Ra (>90Ra Optional)	3000K-6000K, RGB	040RGB, 050, 020RGB, 010, 0-10V	IP68	Tempered Glass
	9W				900Lm					
	12W				1.200Lm					
	25W				2.500Lm					

Model : ZERN-RC-SS160L



Dimension [mm]

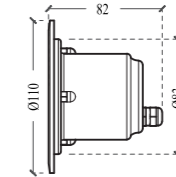

Beam Angle

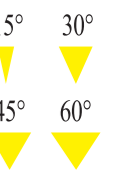

Model : ZERN-RC-SS160L



Dimension [mm]

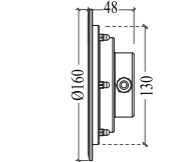

Beam Angle

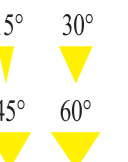

Plastic niche for concrete pool

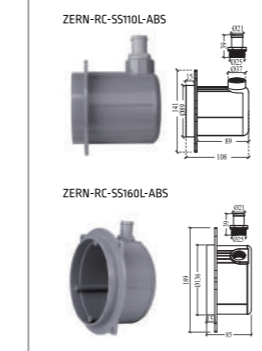

Stainless steel niche for concrete pool

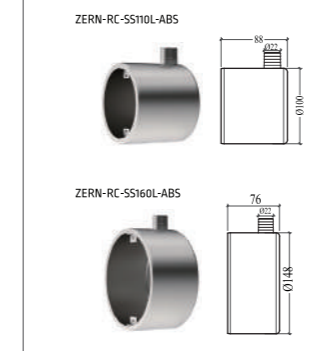

Installation Diagram

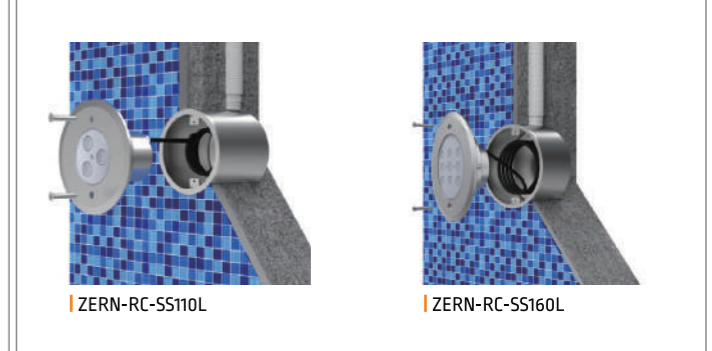

- * Easy maintenance
- Modular LED for easy replacement
- Opening and closing possible of LED module part and power supply part
- Customizable beam angle
- Temperature max 50°



ZERON
NEW LIGHT NEW LIFE

Underwater Light

ZERN-SL150 / SL180



■ Specification



Model	Daya (W)	Input Voltage	Frequency Amp	LED Efikasi	Total Lumen	CRI	Temperatur Warna	Controller	Proteksi	Material
ZERN-SL150	9W 18W	DC 12V, 24V	50/60Hz	100Lm/W	900Lm 1.800Lm	>80Ra [>90Ra Optional]	3000K-6000K, RGB	040RGB, 050, 020RGB, 010, 0-10V, DMX512	IP68	Tempered Glass
ZERN-SL180	12W 18W 25W	DC 12V, 24V	50/60Hz	100Lm/W	1.200Lm 1.800Lm 2.500Lm	>80Ra [>90Ra Optional]	3000K-6000K, RGB	040RGB, 050, 020RGB, 010, 0-10V, DMX512	IP68	Tempered Glass

Model : ZERN-SL150

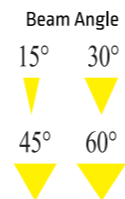
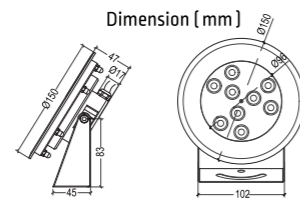

Model : ZERN-SL180

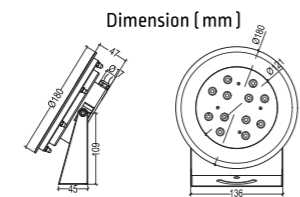

* Easy maintenance
- Modular LED for easy replacement
- Opening and closing possible of LED module part and power supply part
- Customizable beam angle
- Temperature max 50°



ZERON
NEW LIGHT NEW LIFE

Underwater Light

ZERN-FL170-32 / FL192-50



■ Specification



Model	Daya (W)	Input Voltage	Frequency Amp	LED Efikasi	Total Lumen	CRI	Temperatur Warna	Controller	Proteksi	Material
ZERN-FL170-32	9W	DC 12V, 24V	50/60Hz	100Lm/W	900Lm	>80Ra [>90Ra Optional]	3000K-6000K, RGB	040RGB, 050, 020RGB, 010, 0-10V, DMX512	IP68	Tempered Glass
ZERN-FL192-50	9W 18W 30W	DC 12V, 24V	50/60Hz	100Lm/W	900Lm 1.800Lm 3.000Lm	>80Ra [>90Ra Optional]	3000K-6000K, RGB	040RGB, 050, 020RGB, 010, 0-10V, DMX512	IP68	Tempered Glass

Model : ZERN-FL170-32

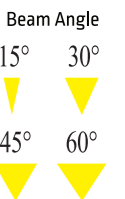
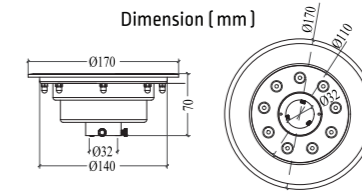

Model : ZERN-FL192-50

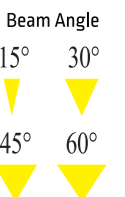
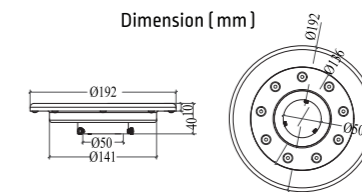

* Easy maintenance
- Modular LED for easy replacement
- Opening and closing possible of LED module part and power supply part
- Customizable beam angle
- Temperature max 50°



ZERON
NEW LIGHT NEW LIFE

Underwater Light
ZERN-RC-SS280L



3.000K 4.000K 5.000K 6.000K

■ Specification

Daya [W]	Input Voltage	Frequency Amp	LED Efikasi	Total Lumen	CRI	Temperatur Warna	Controller	Proteksi	Material
18W	DC 12V, 24V	50/60Hz	100Lm/W	1.800Lm	>80Ra [>90Ra Optional]	3000K-6000K, RGB	040RGB, 050, 020RGB, 010, 0-10V, DMX512	IP68	Tempered Glass
35W				3.500Lm					
50W				5.000Lm					
80W				8.000Lm					
							0-10V		

Model : ZERN-RC-SS280L



Dimension [mm]

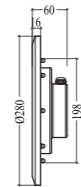

Beam Angle

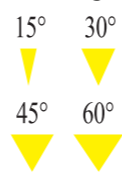

<p>Plastic Niche For Concrete Pool [ZERN-RC-SS280L-ABS]</p>	<p>Stainless Steel Niche For Concrete Pool [ZERN-RC-SS280L-SS]</p>	<p>Plastic Niche For Concrete Pool [ZERN-RC-SS280L-ABSV]</p>	<p>Stainless Steel Niche For Concrete Pool [ZERN-RC-SS280L-SSV]</p>
<p>Installation For Concrete Pool</p>		<p>Installation For Vinyl Liner Pool</p>	

* Easy maintenance
 - Modular LED for easy replacement
 - Opening and closing possible of LED module part and power supply part
 - Customizable beam angle
 - Temperature max 50°

**SPOT
LIGHT**

ZERON
NEW LIGHT NEW LIFE

Spot Light
ZERN-GSL-3W



Specification

Daya (W)	Input Voltage	Frequency Amp	LED Efikasi	Total Lumen	CRI	Temperatur Warna	Beam Angle	Proteksi	Material
3W	AC85-265V	50/60Hz	80Lm/W	240Lm	80Ra	3000K/4000K/6000K	3°/15°/30°	IP67	Die casting aluminium+ tempered glass

Dimension [mm]

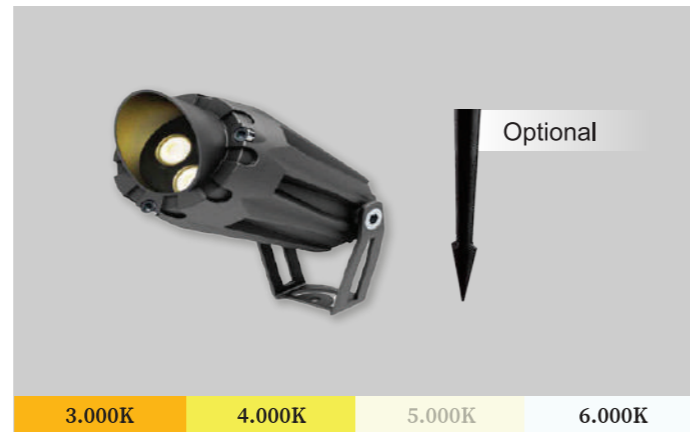
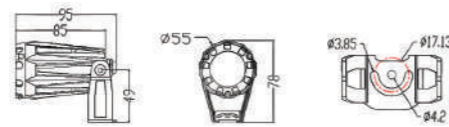

3.000K 4.000K 5.000K 6.000K

ZERON
NEW LIGHT NEW LIFE

Spot Light
ZERN-CSL-5W



Specification

Daya (W)	Input Voltage	Frequency Amp	LED Efikasi	Total Lumen	CRI	Temperatur Warna	Proteksi	Material
5W	AC85-265V	50/60Hz	80Lm/W	400Lm	80Ra	3000K	IP67	Die casting aluminium+ tempered glass

Model : ZERN-GSL-5W



Dimension [mm]

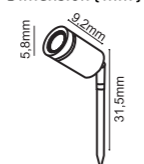

Application



- * Easy maintenance
- Modular LED for easy replacement
- Opening and closing possible of LED module part and power supply part
- Customizable beam angle
- Temperature max 50°



ZERON
NEW LIGHT NEW LIFE

Spot Light
ZERN-GSL-6W/9W



Specification

Daya (W)	Input Voltage	Frequency Amp	LED Efikasi	Total Lumen	CRI	Temperatur Warna	Beam Angle	Proteksi	Material
6W/9W	AC85-265V	50/60Hz	80Lm/W	480Lm / 720Lm	80Ra	3000K/4000K/6000K	15°/30°/ 45°/ 60°	IP67	Die casting aluminium+ tempered glass

Dimension [mm]

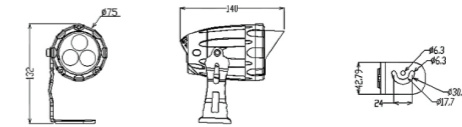

3.000K 4.000K 5.000K 6.000K

ZERON
NEW LIGHT NEW LIFE

Spot Light
ZERN-GSL-10W/12W



Specification

Daya (W)	Input Voltage	Frequency Amp	LED Efikasi	Total Lumen	CRI	Temperatur Warna	Beam Angle	Proteksi	Material
10W/12W	AC85-265V	50/60Hz	80Lm/W	800Lm / 960Lm	80Ra	3000K/4000K/6000K	15°/30°	IP67	Die casting aluminium+ tempered glass

Dimension [mm]

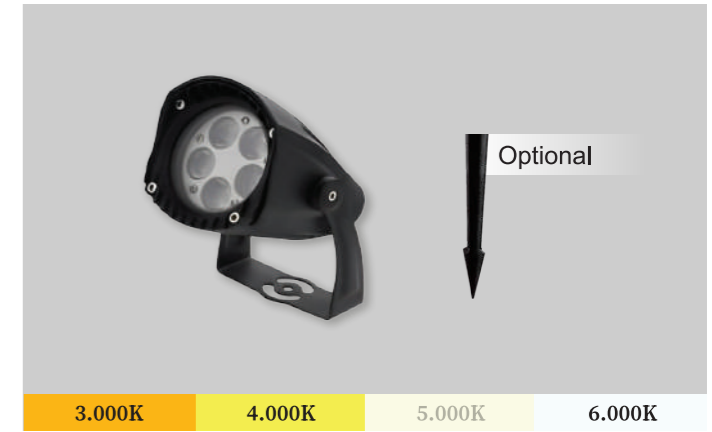
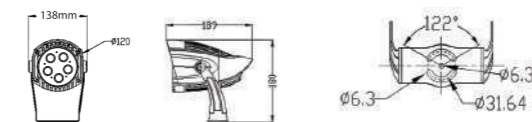

3.000K 4.000K 5.000K 6.000K

- * Easy maintenance
- Modular LED for easy replacement
- Opening and closing possible of LED module part and power supply part
- Customizable beam angle
- Temperature max 50°



ZERON
NEW LIGHT NEW LIFE

Spot Light
ZERN-GSL-18W/27W



Specification

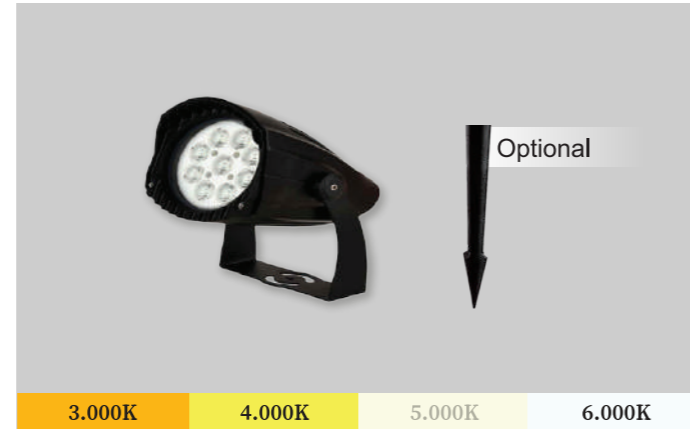

3.000K 4.000K 5.000K 6.000K

Daya (W)	Input Voltage	Frequency Amp	LED Efikasi	Total Lumen	CRI	Temperatur Warna	Beam Angle	Proteksi	Material
18W/27W	AC85-265V	50/60Hz	80Lm/W	1.440Lm / 2.160Lm	80Ra	3000K/4000K/6000K	15°/30°	IP67	Die casting aluminium+ tempered glass

Dimension [mm]

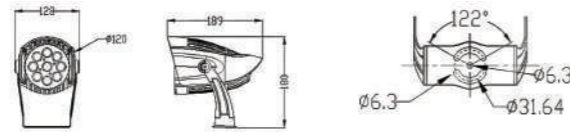

ZERON
NEW LIGHT NEW LIFE

Spot Light
ZERN-GSL-36W



Specification



3.000K 4.000K 5.000K 6.000K

Daya (W)	Input Voltage	Frequency Amp	LED Efikasi	Total Lumen	CRI	Temperatur Warna	Beam Angle	Proteksi	Material
36W	AC85-265V	50/60Hz	80Lm/W	2.880Lm	80Ra	3000K/4000K/6000K	15°/25°/45°	IP67	Die casting aluminium+ tempered glass

Model : ZERN-GSL-36W



Dimension [mm]

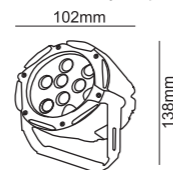

Application

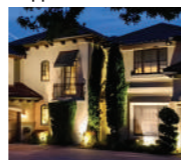

- * Easy maintenance
- Modular LED for easy replacement
- Opening and closing possible of LED module part and power supply part
- Customizable beam angle
- Temperature max 50°



ZERON
NEW LIGHT NEW LIFE

Spot Light
ZERN-GSL-4W/8W



Specification

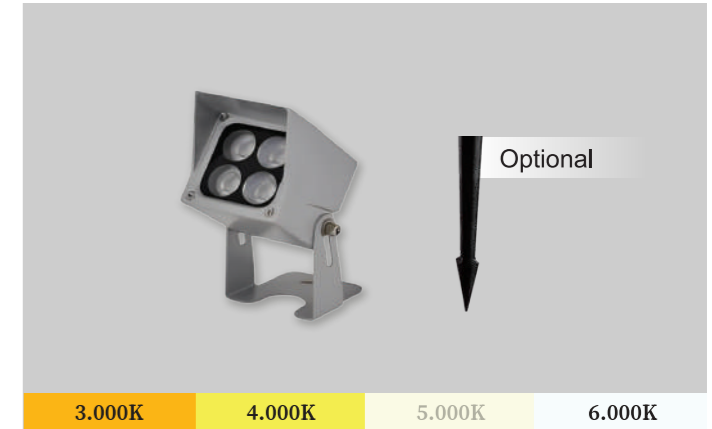

3.000K 4.000K 5.000K 6.000K

Daya (W)	Input Voltage	Frequency Amp	LED Efikasi	Total Lumen	CRI	Temperatur Warna	Proteksi	Material
4W/8W	AC85-265V	50/60Hz	80Lm/W	320Lm / 640Lm	80Ra	3000K/4000K/6000K	IP67	Die casting aluminium+ tempered glass

Dimension [mm]

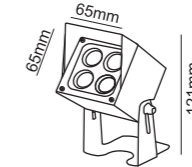

Application



- * Easy maintenance
- Modular LED for easy replacement
- Opening and closing possible of LED module part and power supply part
- Customizable beam angle
- Temperature max 50°





ZERON

NEW LIGHT NEW LIFE

Spot Light

ZERN-GSLS-18W/27W



Specification

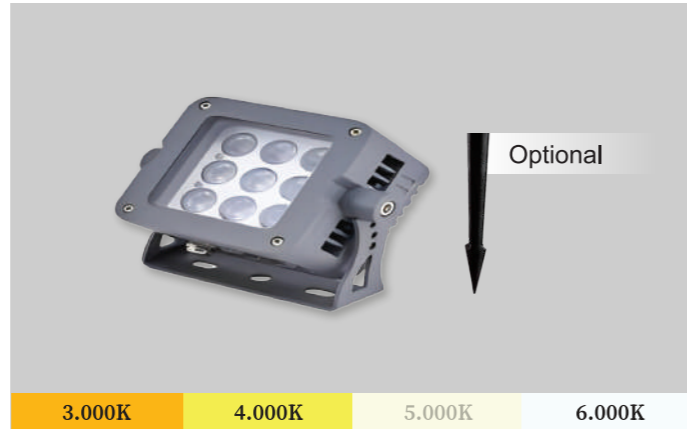

Daya (W)	Input Voltage	Frequency Amp	LED Efikasi	Total Lumen	CRI	Temperatur Warna	Proteksi	Material
18W/27W	AC85-265V	50/60Hz	80Lm/W	1.440Lm / 2.160Lm	80Ra	3000K/4000K/6000K	IP67	Die casting aluminium+ tempered glass

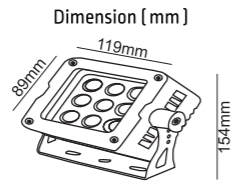

ZERON

NEW LIGHT NEW LIFE

Spot Light

ZERN-GSLS-36W/48W



Specification

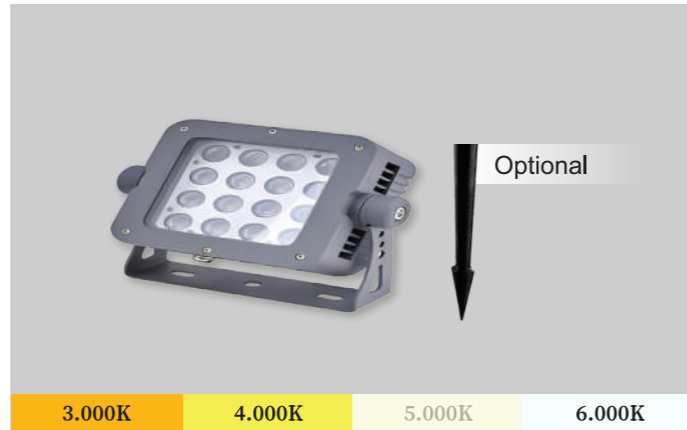

Daya (W)	Input Voltage	Frequency Amp	LED Efikasi	Total Lumen	CRI	Temperatur Warna	Proteksi	Material
36W/48W	AC85-265V	50/60Hz	80Lm/W	2.880Lm/3.840	80Ra	3000K/4000K/6000K	IP67	Die casting aluminium+ tempered glass

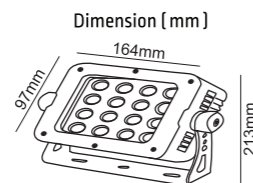

STEP LIGHT

* Easy maintenance
 - Modular LED for easy replacement
 - Opening and closing possible of LED module part and power supply part
 - Customizable beam angle
 - Temperature max 50°



ZERON
NEW LIGHT NEW LIFE

Step Light
ZERN-SLS-3W



■ Specification

Daya (W)	Input Voltage	Frequency Amp	LED Efikasi	Total Lumen	CRI	Temperatur Warna	Proteksi	Material
3/6W	AC85-265V	50/60Hz	100Lm/W	300Lm/600Lm	80Ra	3000K/6000K	IP65	Aluminium

Model : ZERN-SLS-3W

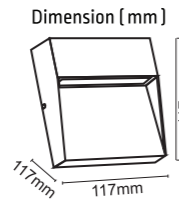

Application

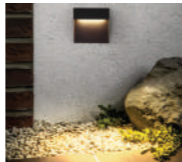

ZERON
NEW LIGHT NEW LIFE

Step Light
ZERN-RLS-3W



■ Specification

Daya (W)	Input Voltage	Frequency Amp	LED Efikasi	Total Lumen	CRI	Temperatur Warna	Proteksi	Material
3W	AC85-265V	50/60Hz	100Lm/W	300Lm	80Ra	3000K/6000K	IP65	Aluminium

Model : ZERN-RLS-3W

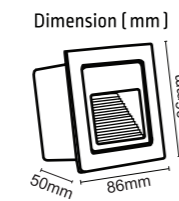
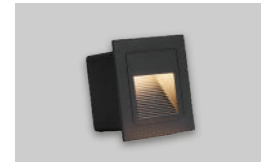

Application

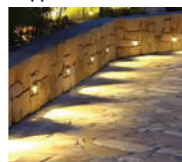

- * Easy maintenance
- Modular LED for easy replacement
- Opening and closing possible of LED module part and power supply part
- Customizable beam angle
- Temperature max 50°



ZERON
NEW LIGHT NEW LIFE

Step Light
ZERN-SLR-3W



■ Specification

Daya (W)	Input Voltage	Frequency Amp	LED Efikasi	Total Lumen	CRI	Temperatur Warna	Proteksi	Material
3W	AC85-265V	50/60Hz	100Lm/W	300Lm	80Ra	3000K/6000K	IP65	Aluminium

Model : ZERN-SLR-3W

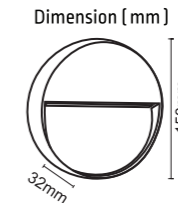

Application



ZERON
NEW LIGHT NEW LIFE

Step Light
ZERN-SLR-5W



■ Specification

Daya (W)	Input Voltage	Frequency Amp	LED Efikasi	Total Lumen	CRI	Temperatur Warna	Proteksi	Material
5W	AC 85-265V	50/60Hz	100Lm/W	500Lm	80Ra	3000K/6000K	IP65	Aluminium

Model : ZERN-SLR-5W

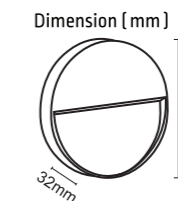
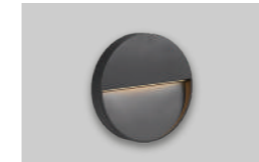

Application



- * Easy maintenance
- Modular LED for easy replacement
- Opening and closing possible of LED module part and power supply part
- Customizable beam angle
- Temperature max 50°



ZERON
NEW LIGHT NEW LIFE

Step Light
ZERN-RLR-3W



■ Specification



3.000K 4.000K 5.000K 6.000K

Daya (W)	Input Voltage	Frequency Amp	LED Efikasi	Total Lumen	CRI	Temperatur Warna	Proteksi	Material
3W	AC85-265V	50/60Hz	100Lm/W	300Lm	80Ra	3000K/6000K	IP65	Aluminium

Model : ZERN-RLR-3W



Dimension [mm]

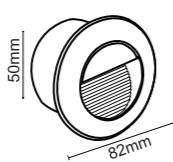

Application

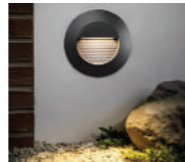

ZERON
NEW LIGHT NEW LIFE

Step Light
ZERN-SL-3W



■ Specification



3.000K 4.000K 5.000K 6.000K

Daya (W)	Input Voltage	Frequency Amp	LED Efikasi	Total Lumen	CRI	Temperatur Warna	Proteksi	Material
3W	AC85-265V	50/60Hz	100Lm/W	300Lm	80Ra	3000K/6000K	IP65	Aluminium

Model : ZERN-SL-3W



Dimension [mm]

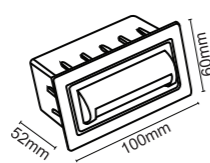

Application



- * Easy maintenance
- Modular LED for easy replacement
- Opening and closing possible of LED module part and power supply part
- Customizable beam angle
- Temperature max 50°



ZERON
NEW LIGHT NEW LIFE

Step Light
ZERN-SL-5W



■ Specification



3.000K 4.000K 5.000K 6.000K

Daya (W)	Input Voltage	Frequency Amp	LED Efikasi	Total Lumen	CRI	Temperatur Warna	Proteksi	Material
5W	AC85-265V	50/60Hz	100Lm/W	500Lm	80Ra	3000K/6000K	IP65	Aluminium

Model : ZERN-SL-5W



Dimension [mm]

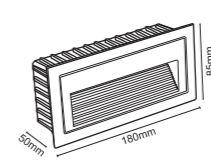

Application



ZERON
NEW LIGHT NEW LIFE

Step Light
ZERN-SL-10W



■ Specification



3.000K 4.000K 5.000K 6.000K

Daya (W)	Input Voltage	Frequency Amp	LED Efikasi	Total Lumen	CRI	Temperatur Warna	Proteksi	Material
10W	AC85-265V	50/60Hz	100Lm/W	500Lm/1.000Lm	80Ra	3000K/6000K	IP65	Aluminium

Model : ZERN-SL-10W

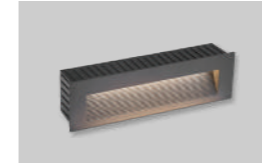

Dimension [mm]

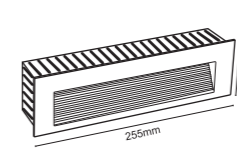

Application

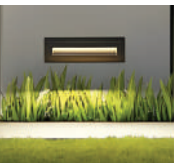

- * Easy maintenance
- Modular LED for easy replacement
- Opening and closing possible of LED module part and power supply part
- Customizable beam angle
- Temperature max 50°



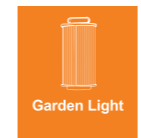

GARDEN LIGHT

ZERON NEW LIGHT NEW LIFE

Garden Light Birdcage



■ Specification



Daya (W)	Input Voltage	Frequency Amp	LED Efikasi	Total Lumen	CRI	Temperatur Warna	Proteksi	Material
16W	AC100-240V	50/60Hz	90Lm/W	1.440Lm	80Ra	3000K	IP65	Iron + Stone Light Cover

Model : Birdcage-16W



Dimension [mm]



Application



ZERON NEW LIGHT NEW LIFE

Garden Light ZERN-TTG-15W



■ Specification



Daya (W)	Input Voltage	Frequency Amp	LED Efikasi	Total Lumen	CRI	Temperatur Warna	Proteksi	Material
15W	AC100-240V	50/60Hz	100Lm/W	1.500Lm	80Ra	3000K/6000K	IP65	Iron + Stone Light Cover

Model : ZERN-TTG-15W

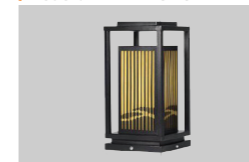

Dimension [mm]

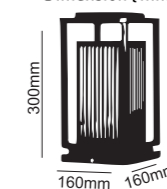

Application



- * Easy maintenance
- Modular LED for easy replacement
- Opening and closing possible of LED module part and power supply part
- Customizable beam angle
- Temperature max 50°

ZERON
NEW LIGHT NEW LIFE

Garden Light
ZERN-LANT-12W



■ Specification



Daya (W)	Input Voltage	Frequency Amp	LED Efikasi	Total Lumen	CRI	Temperatur Warna	Proteksi	Material
12W	AC100-240V	50/60Hz	80Lm/W	960Lm	80Ra	3000K	IP65	Iron + Stone Light Cover

Application



Model : WL-ZFKT-05WX2



Dimension (mm)

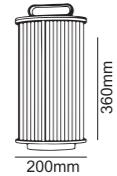

- * Easy maintenance
- Modular LED for easy replacement
- Opening and closing possible of LED module part and power supply part
- Customizable beam angle
- Temperature max 50°



ZERON
NEW LIGHT NEW LIFE

Garden Light
ZERN-118A



■ Specification



Daya (W)	Input Voltage	Frequency Amp	LED Efikasi	Total Lumen	CRI	Temperatur Warna	Proteksi	Beam Angle	Material
60W 80W 100W	AC85-265V	50/60Hz	100Lm/W	6.000Lm 8.000Lm 10.000Lm	>70Ra	3000K/4000K/6000K	IP65	60°/90°/120°	Cast Aluminium+4.0mm +PC Lens

Model : ZERN-118A-60W



Dimension (mm)

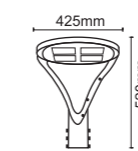

Model : ZERN-118A-80W



Dimension (mm)

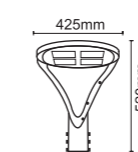

Model : ZERN-118A-100W



Dimension (mm)

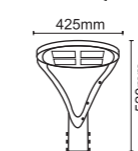

Application



- * Easy maintenance
- Modular LED for easy replacement
- Opening and closing possible of LED module part and power supply part
- Customizable beam angle
- Temperature max 50°





Wall Lamp

ELX-ZFKT



Specification



3.000K 4.000K 5.000K 6.000K

Daya (W)	Input Voltage	Frequency Amp	LED Efikasi	Total Lumen	CRI	Temperatur Warna	Proteksi	Material
3W 5W 10W	AC100-240V	50/60Hz	80Lm/W	240Lm 400Lm 800Lm	>80Ra [>90Ra Optional]	3000K/4000K/6000K	IP65	Die Casting Aluminium

Model : ELX-ZFKT-03WX2



Dimension (mm)

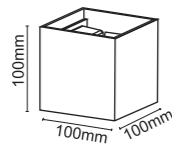

Application



Model : ELX-ZFKT-05WX2



Dimension (mm)

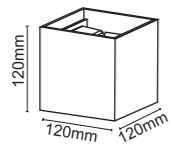

Model : ELX-ZFKT-10WX2



Dimension (mm)

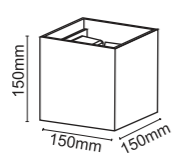

- * Easy maintenance
- Modular LED for easy replacement
- Opening and closing possible of LED module part and power supply part
- Customizable beam angle
- Temperature max 50°



Wall Lamp

ELX-WL



Specification



3.000K 4.000K 5.000K 6.000K

Daya (W)	Input Voltage	Frequency Amp	LED Efikasi	Total Lumen	CRI	Temperatur Warna	Proteksi	Material
3W 6W 12W 18W 24W	AC100-240V	50/60Hz	80Lm/W	240Lm 480Lm 960Lm 1.440Lm 1.920Lm	>80Ra [>90Ra Optional]	3000K/4000K/6000K	IP65	Die Casting Aluminium

Model : ELX-WL65160-03WX1



Dimension (mm)

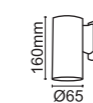

Model : ELX-WL90160-06WX1



Dimension (mm)

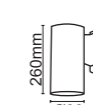

Model : ELX-WL110200-12WX1



Dimension (mm)

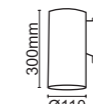

Model : ELX-WL145200-18WX1



Dimension (mm)

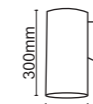

Model : ELX-WL160200-24WX1



Dimension (mm)

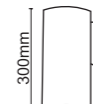

Application

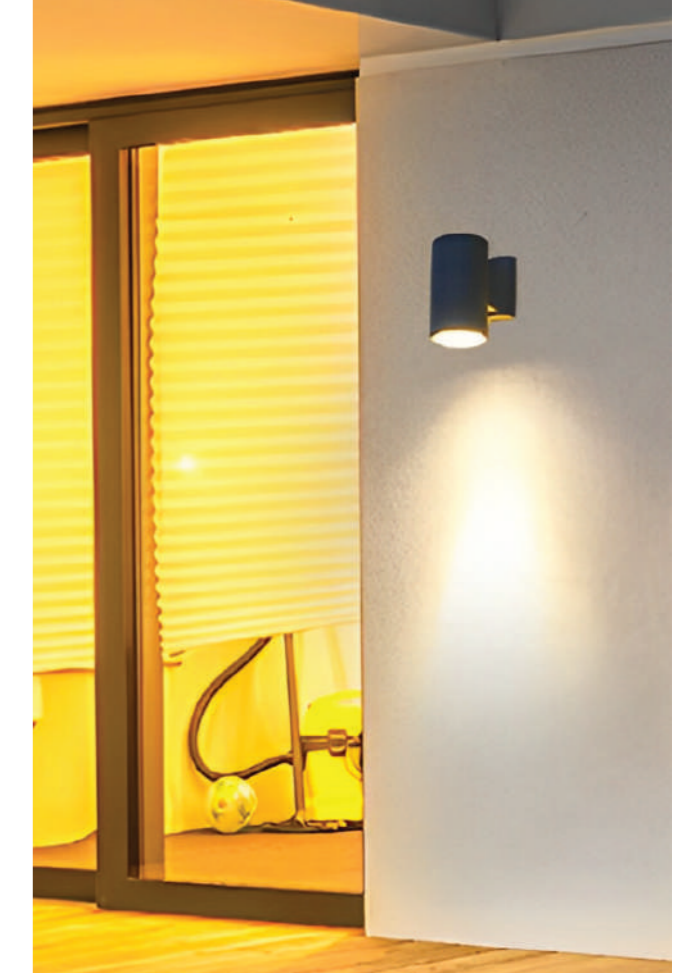

- * Easy maintenance
- Modular LED for easy replacement
- Opening and closing possible of LED module part and power supply part
- Customizable beam angle
- Temperature max 50°





Wall Lamp

ELX-WL



Specification



3.000K 4.000K 5.000K 6.000K

Daya (W)	Input Voltage	Frequency Amp	LED Efikasi	Total Lumen	CRI	Temperatur Warna	Proteksi	Material
6W 12W 24W 36W 48W	AC100-240V	50/60Hz	80Lm/W	240Lm 480Lm 960Lm 1.440Lm 1.920Lm	>80Ra [>90Ra Optional]	3000K/4000K/6000K	IP65	Die Casting Aluminium

Model : ELX-WL90260-03WX2



Dimension (mm)

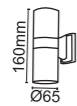

Model : ELX-WL90260-06WX2



Dimension (mm)

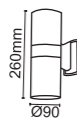

Model : ELX-WL110300-12WX2



Dimension (mm)

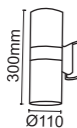

Model : ELX-WL145300-18WX2



Dimension (mm)

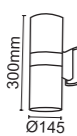

Model : ELX-WL160300-24WX2



Dimension (mm)

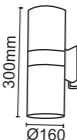

Application



Wall Lamp

ELX-LWA



Specification



3.000K 4.000K 5.000K 6.000K

Daya (W)	Input Voltage	Frequency Amp	LED Efikasi	Total Lumen	CRI	Temperatur Warna	Proteksi	Material
3W 6W 12W 18W	AC100-240V	50/60Hz	80Lm/W	240Lm 480Lm 960Lm 1.440Lm	>80Ra [>90Ra Optional]	3000K/4000K/6000K	IP65	Die Casting Aluminium

Model : ELX-LWA216-3W



Dimension (mm)



Model : ELX-LWA216-6W



Dimension (mm)

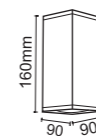

Model : ELX-LWA216-12W



Dimension (mm)

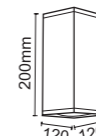

Model : ELX-LWA216-18W



Dimension (mm)

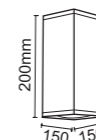

Application

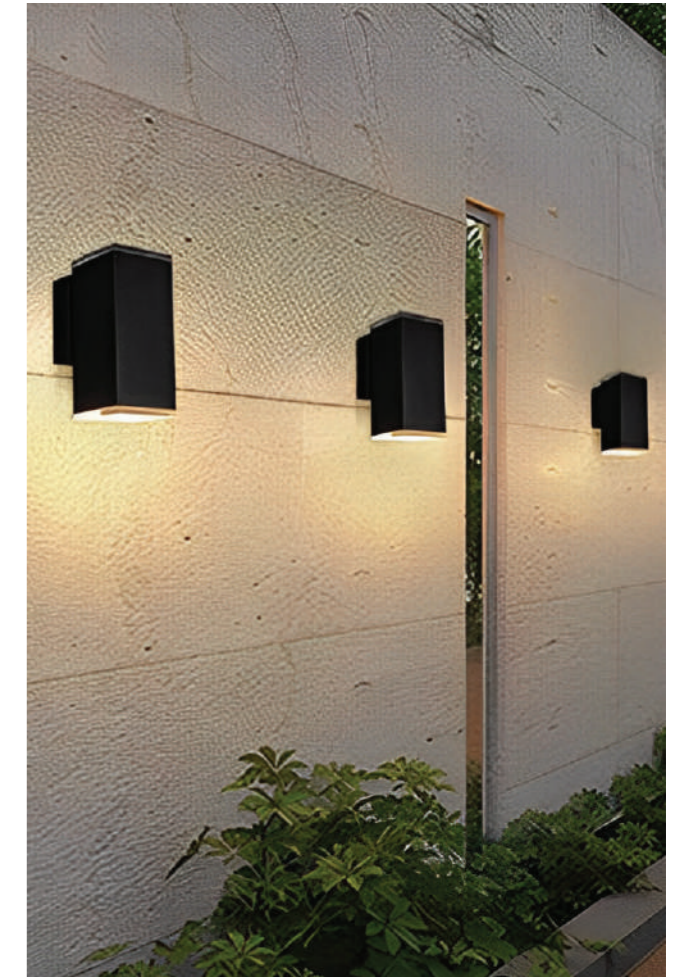

* Easy maintenance
 - Modular LED for easy replacement
 - Opening and closing possible of LED module part and power supply part
 - Customizable beam angle
 - Temperature max 50°



* Easy maintenance
 - Modular LED for easy replacement
 - Opening and closing possible of LED module part and power supply part
 - Customizable beam angle
 - Temperature max 50°





Wall Lamp

ELX-WL



Specification

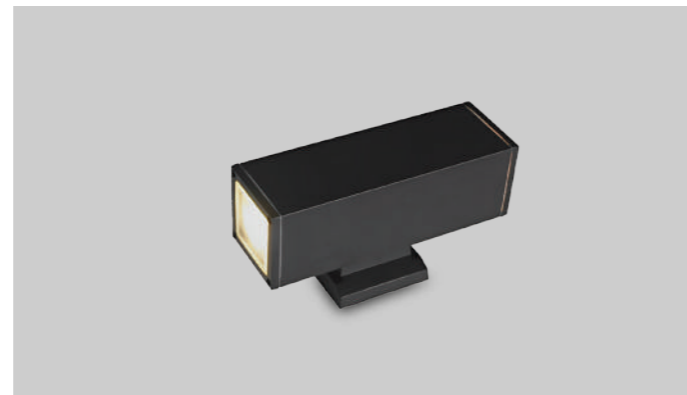

3.000K 4.000K 5.000K 6.000K

Daya (W)	Input Voltage	Frequency Amp	LED Efikasi	Total Lumen	CRI	Temperatur Warna	Proteksi	Material
6W 12W 24W 36W	AC100-240V	50/60Hz	80Lm/W	480Lm 960Lm 1.920Lm 2.880Lm	>80Ra (>90Ra Optional)	3000K/4000K/6000K	IP65	Die Casting Aluminium

Model : ELX-WL6363160-03WX2



Dimension (mm)

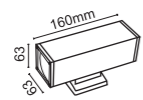

Model : ELX-WL9090260-06WX2



Dimension (mm)

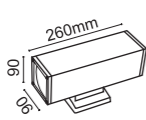

Model : ELX-WL120120300-12WX2



Dimension (mm)

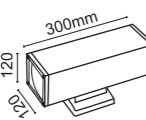

Model : ELX-WL150150300-18WX2



Dimension (mm)

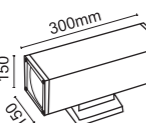

Application



Wall Lamp

ELX-XMY



Specification



3.000K 4.000K 5.000K 6.000K

Daya (W)	Input Voltage	Frequency Amp	LED Efikasi	Total Lumen	CRI	Temperatur Warna	Proteksi	Material
6W 10W 20W 30W	AC100-240V	50/60Hz	80Lm/W	480Lm 800Lm 1.600Lm 2.400Lm	>80Ra (>90Ra Optional)	3000K/4000K/6000K	IP65	Die Casting Aluminium

Model : ELX-XMY-03WX2



Dimension (mm)



Model : ELX-XMY-05WX2



Dimension (mm)



Model : ELX-XMY-10WX2



Dimension (mm)



Model : ELX-XMY-15WX2



Dimension (mm)



Application



* Easy maintenance
 - Modular LED for easy replacement
 - Opening and closing possible of LED module part and power supply part
 - Customizable beam angle
 - Temperature max 50°

* Easy maintenance
 - Modular LED for easy replacement
 - Opening and closing possible of LED module part and power supply part
 - Customizable beam angle
 - Temperature max 50°



Wall Lamp
ELX-YQS



Specification



3.000K 4.000K 5.000K 6.000K

Daya (W)	Input Voltage	Frequency Amp	LED Efikasi	Total Lumen	CRI	Temperatur Warna	Proteksi	Material
7W 10W 12W	AC100-240V	50/60Hz	80Lm/W	560Lm 800Lm 960Lm	>80Ra [>90Ra Optional]	3000K/4000K/6000K	IP65	Die Casting Aluminium

Model : WL-YQS-7W



Dimension (mm)

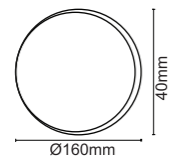

Application



Model : WL-YQS-10W



Dimension (mm)

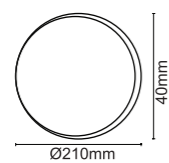

Model : WL-YQS-12W



Dimension (mm)

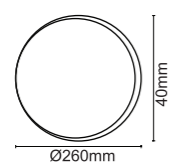

- * Easy maintenance
- Modular LED for easy replacement
- Opening and closing possible of LED module part and power supply part
- Customizable beam angle
- Temperature max 50°



Wall Lamp
ELX-YKLF



Specification

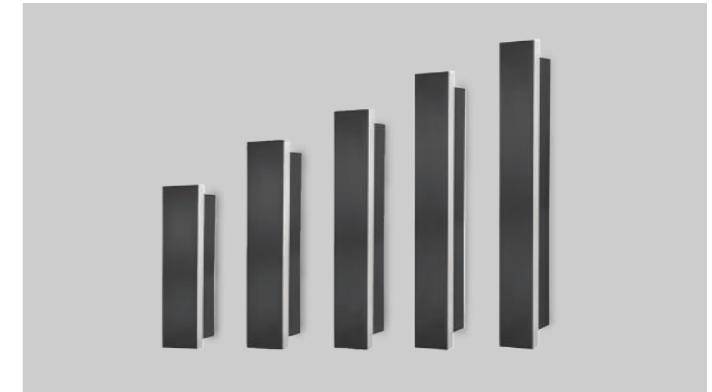

3.000K 4.000K 5.000K 6.000K

Daya (W)	Input Voltage	Frequency Amp	LED Efikasi	Total Lumen	CRI	Temperatur Warna	Proteksi	Material
16W 24W 32W 40W 48W	AC100-240V	50/60Hz	80Lm/W	1.280Lm 1.920Lm 2.560Lm 3.200Lm 3.840Lm	>80Ra [>90Ra Optional]	3000K/4000K/6000K	IP65	Die Casting Aluminium

Model : WL-YKLF



Dimension (mm)

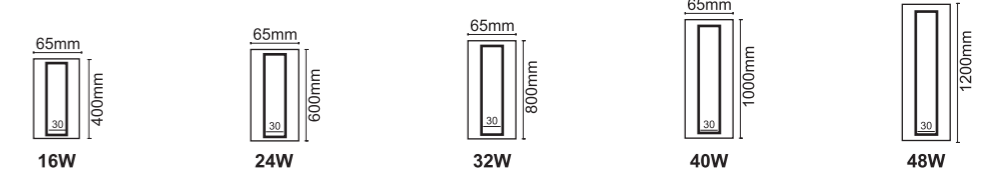

Application



- * Easy maintenance
- Modular LED for easy replacement
- Opening and closing possible of LED module part and power supply part
- Customizable beam angle
- Temperature max 50°



ECO
LUXON
LED Bollard Light
ELX-GBL-4W



■ Specification

Daya (W)	Input Voltage	Frequency Amp	LED Efikasi	Total Lumen	CRI	Temperatur Warna	Proteksi	Material
4W	DC 24V	50/60Hz	100Lm/W	400Lm	80Ra	3000K	IP65	Aluminium



Model : ELX-GBL



Dimension (mm)

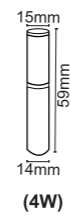
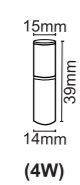

Application



- * Easy maintenance
- Modular LED for easy replacement
- Opening and closing possible of LED module part and power supply part
- Customizable beam angle
- Temperature max 50°



ECO
LUXON
LED Bollard Light
ELX-GBL-6W



■ Specification

Daya (W)	Input Voltage	Frequency Amp	LED Efikasi	Total Lumen	CRI	Temperatur Warna	Proteksi	Material
6W	AC100-240V	50/60Hz	70Lm/W	420Lm	80Ra	3000K	IP65	Pure Aluminium



Model : ELX-GBL-6W



Dimension (mm)

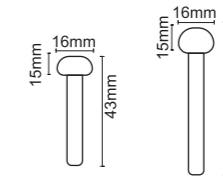

Application



ECO
LUXON
LED Bollard Light
ELX-GBL-10W



■ Specification

Daya (W)	Input Voltage	Frequency Amp	LED Efikasi	Total Lumen	CRI	Temperatur Warna	Proteksi	Material
10W	AC100-240V	50/60Hz	100Lm/W	1.000Lm	90Ra	3000K	IP65	Pure Aluminium+Acrylic



Model : ELX-GBL-10W



Dimension (mm)

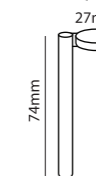

Application



- * Easy maintenance
- Modular LED for easy replacement
- Opening and closing possible of LED module part and power supply part
- Customizable beam angle
- Temperature max 50°



ACCESSORIES



Accessories SMPS Indoor SMPS-INDOOR



Daya (W)	Input Voltage	Output Voltage	Frequency Amp	Output Ampere	Material	Proteksi	Dimensi	Berat
36W	AC100-265V	DC 12V	50/60Hz	3A	Aluminium	IP20	85x58x33mm	225gr
60W				5A			110x78x35mm	354gr
120W				10A			198x98x41mm	512gr
180W				15A			198x98x41mm	558gr



Accessories SMPS Outdoor SMPS-OUTDOOR



Daya (W)	Input Voltage	Output Voltage	Frequency Amp	Input Ampere	Output Ampere	Proteksi	Berat	Material
50W	AC90-250V	DC 12V	50/60Hz	AC 1.2-0.45A	DC 4.16A	IP68	400gr	Aluminium Die Casting
100W	AC90-250V	DC 12V	50/60Hz	AC 2A	DC 8.33A	IP68	936gr	Aluminium Die Casting

* Easy maintenance
 - Modular LED for easy replacement
 - Opening and closing possible of LED module part and power supply part
 - Customizable beam angle
 - Temperature max 50°

ECO
LUXON
Accessories SMPS
DRIVER-MR16



Daya (W)	Input Voltage	Output Voltage	Frequency Amp	Input Ampere	Output Ampere	Proteksi	Berat	Material
8W	AC 85-265V	DC 12V	50/60Hz	AC 36mA	DC 600mA	IP20	28gr	Plastik

ECO
LUXON
Accessories Emergency
EMERGENCY BATTERY 28W



Daya (W)	Input Voltage	Output Voltage	Frequency Amp	Battery Capacity	Battery Type	Dimensi	Berat	Material
28W	AC 220 ± 10%	AC 200-240V	50/60Hz	2.400mAh	Lithium Battery	140x48x35mm	400gr	Plastic Fire Reterdant

ECO
LUXON
Accessories SMPS
DRIVER DIMMABLE 18W



Daya (W)	Input Voltage	Output Voltage	Frequency Amp	Input Ampere	Output Ampere	Proteksi	Berat	Material
18W	DC 15-60V	DC 12V	50/60Hz	AC 80mA	DC 280mA	IP20	47gr	Plastik

ECO
LUXON
Accessories Emergency
EMERGENCY BATTERY 50W



Daya (W)	Input Voltage	Output Voltage	Frequency Amp	Battery Capacity	Battery Type	Dimensi	Berat	Material
50W	AC 220 ± 10%	AC 200-240V	50/60Hz	6.400mAh	Lithium Battery	200x70x45mm	936gr	Aluminium

* Easy maintenance
- Modular LED for easy replacement
- Opening and closing possible of LED module part and power supply part
- Customizable beam angle
- Temperature max 50°

* Easy maintenance
- Modular LED for easy replacement
- Opening and closing possible of LED module part and power supply part
- Customizable beam angle
- Temperature max 50°

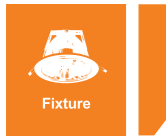

ECO LUXON

Downlight Fixture

SANDBLAST / CHROME



Reflector Type	Type	Fitting	Daya Maksimal	Cut Off	Material
Sandblast Chrome	3.5 inch	E27 Ceramic	100W	889mm	Aluminium
	4 inch			1.016mm	
	5 inch			1.270mm	
	6 inch			1.524mm	

ECO LUXON

MR16 Fixture

ADJ1 / ADJ2



Type	Fitting	Daya Maksimal	Cut Off	Material
ADJ1	GU5.3	50W	Front Open	Plastic
ADJ2	GU5.3	50W	Put-back	Plastic

PERFORMANCE & FACTORY

* Easy maintenance
 - Modular LED for easy replacement
 - Opening and closing possible of LED module part and power supply part
 - Customizable beam angle
 - Temperature max 50°



PERFORMANCE



PARKING



SHOPING MALL



CLASSROOM



CANOPY



MOSQUE



HOTEL ROOM

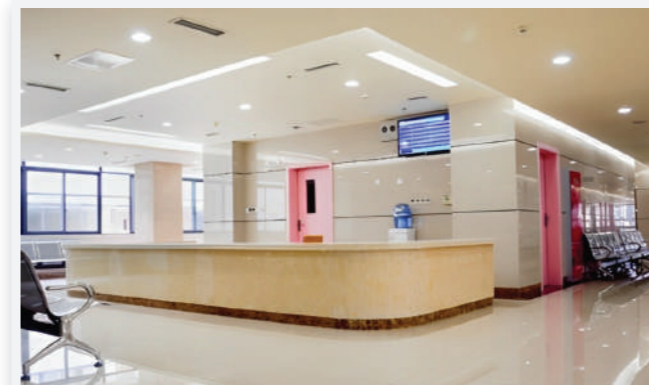

HOSPITAL



OFFICE



GARMENT FACTORY



WAREHOUSE

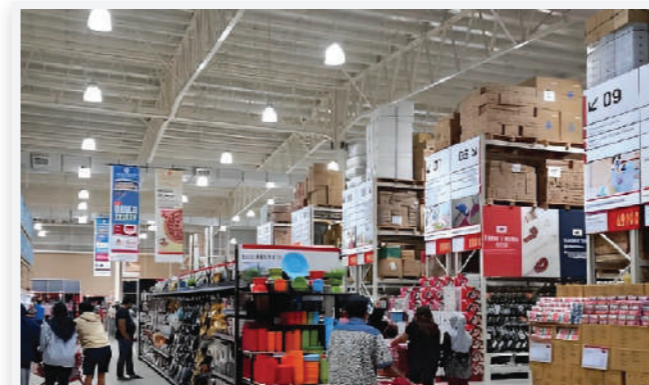

SUPER MARKET

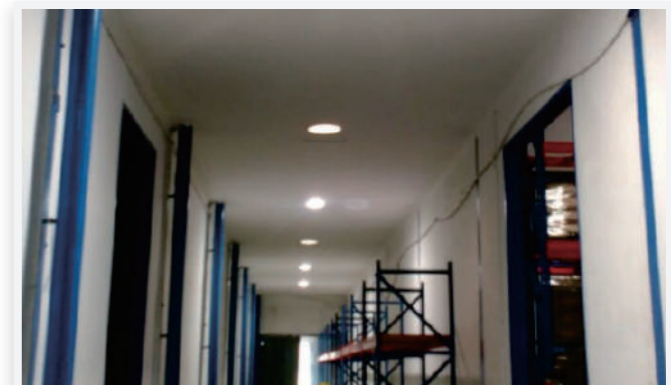

CORRIDOR



TOLL GATE



LOBBY BUILDING



GAS STATION

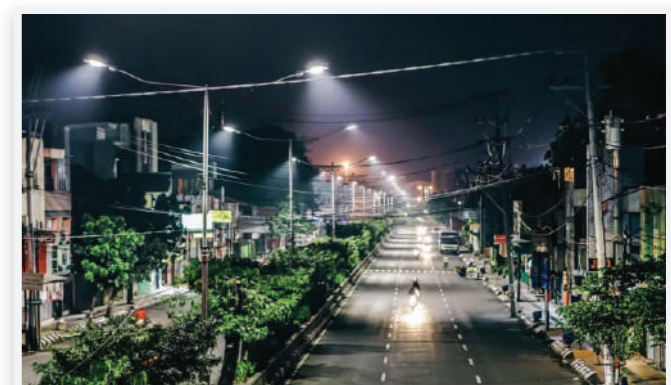

HIGHWAY

FACTORY

PRODUCT LINE



PACKING LINE



MATERIAL WAREHOUSE



FINISH GOOD WAREHOUSE



DOWNLIGHT AGING MACHINE



STREET LIGHT AGING MACHINE



FINISH GOOD WAREHOUSE



TUBELIGHT AGING MACHINE



LASER MARKING MACHINE



FACTORY

SPECTROPHOTO COLORMETER MACHINE



IP TEST MACHINE



THD TEST MACHINE



Hi POT TEST MACHINE

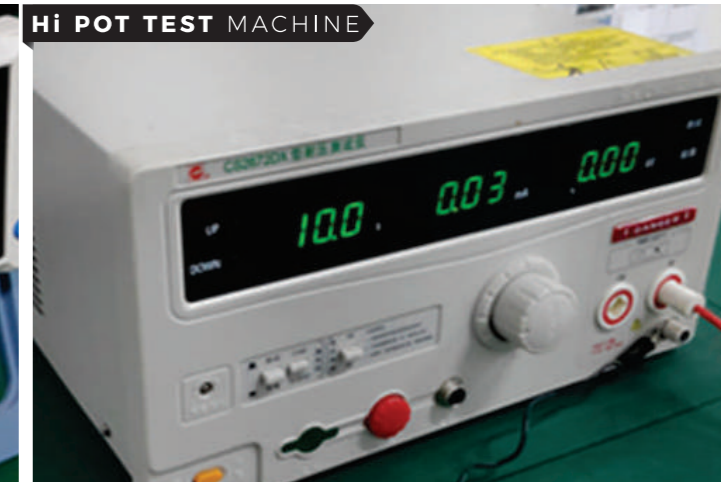

SMT MACHINE

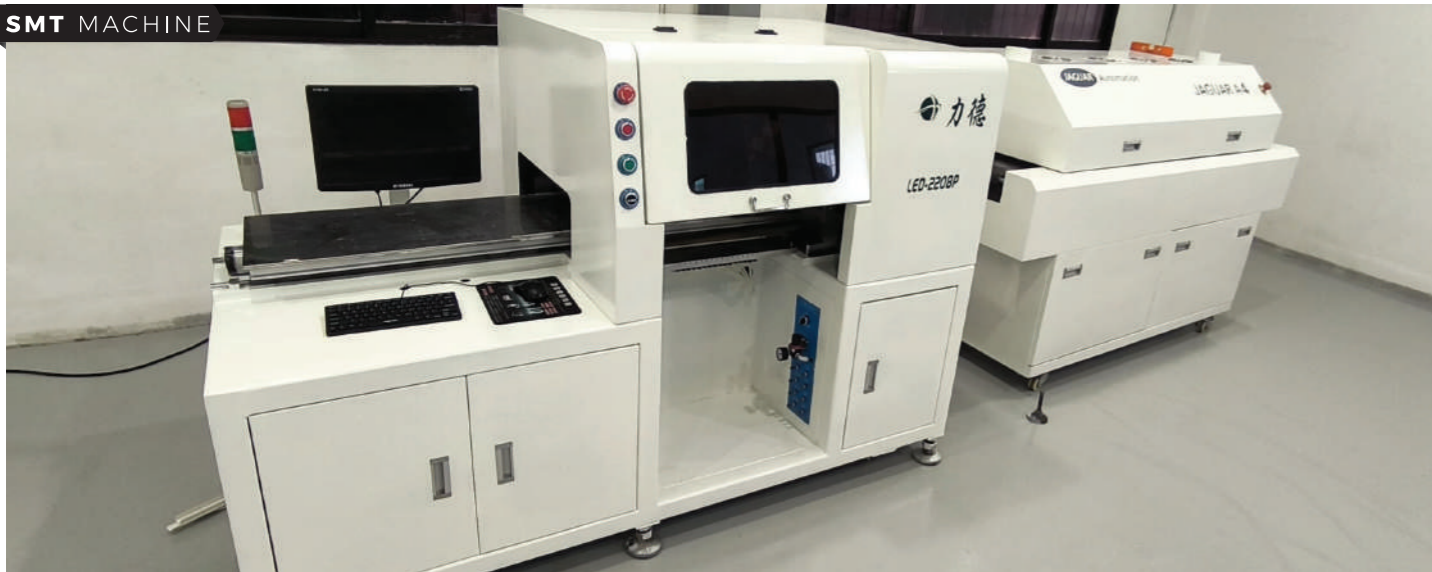

INSULATION TEST MACHINE

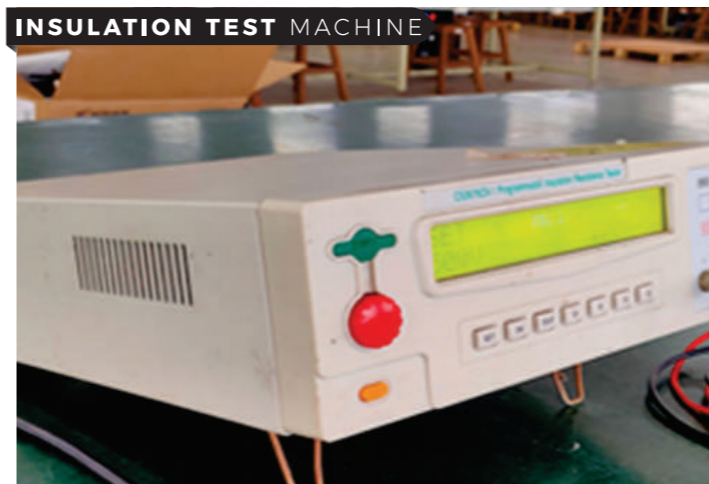

EARTH TEST MACHINE



VIBRATOR MACHINE



GONIOPHOTOMETER MACHINE

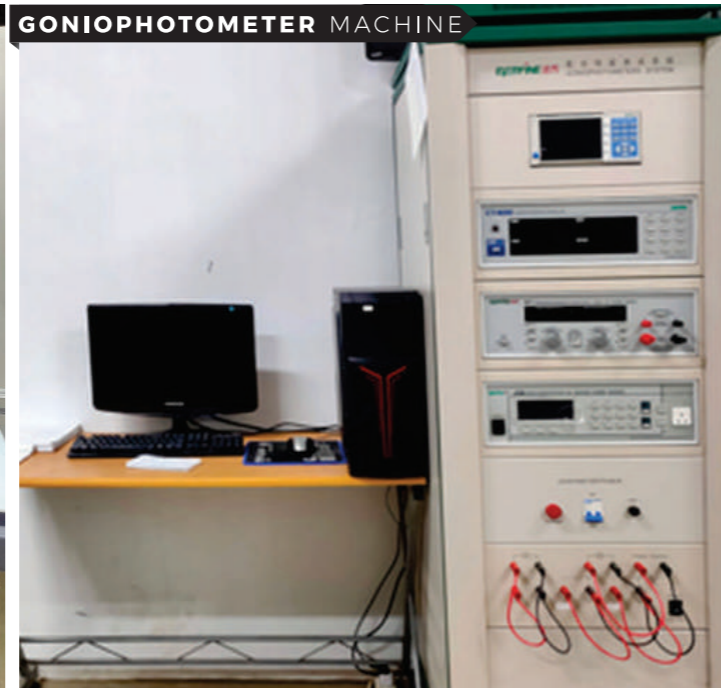

TEMPERATURE & HUMIDITY MACHINE



GONIOPHOTOMETER MACHINE



ZERON
NEW LIGHT NEW LIFE

ECO
LUXON



Scan to Website

RETAIL

LTC GLODOK

- Gama Light
- Glodok LED
- Nur Padhi
- Aneka Lampu
- Diva Abadi
- Mentari Solar LED
- Sun Led
- Sinar Glodok Lestari
- Power LED
- Sinar Intan Mandiri
- Bukit Intan
- Multi Sarana
- Morthen
- Sumber Jaya
- Benua Mas
- Kurnia Jaya Abadi
- Berkat Energi Solar
- Sinar Surya
- Mutiara Lighting
- Sumber Sinar Mas
- Prima Jaya
- Kurnia Jaya
- Surya Mas
- Toya Elektrik
- Surya Gemilang
- Istana Lampu.

PLAZA KENARI MAS

- Pioneer Mas
- Alika Elektrik
- Makmur Mandiri
- Elca Jaya Mandiri
- Unggul Elektrik
- Gemilang Elec. Abadi II
- Sinar Maju Elektrik
- Lucky Star Elektrik
- Mitra Jaya Elektrik
- Jaya Elektrik
- Sinar Mas Elektrindo
- Pe Ong Elektrik
- Anugerah Elektrik
- Valens Elektrik
- Jaya Mitra Elektrik
- Bintang 8 Saudara
- Smart LED
- Surya Lestari
- Star LED
- Mutiara Jaya
- Sinar Jaya Mandiri
- Kiki Elektrik
- Putra Mandiri
- Jaya Sentosa
- Dwi Elektrik
- Graha Elektrik.

AGENT



PUTRA
FARDONI
GRUP



Synberta
PT Syn Berta Utama



SU
PT Saudara Utama
International



PT Jin Sung Tech



PT. REVOLUSI ENERGI MANDIRI
SPECIALIST ELECTRICAL AND FILTER SYSTEM



JYB TRADE
PT JYB Jaya Mandiri

The photos in this catalog may differ from actual colors.

If you copy and edit the contents of this catalog without permission, can be punished by copyright law.
The specifications in this catalog may change and if requested, possible to get certification.